



awex[®]
EMERGENCY LIGHTING

CATALIST NO 22.1

WE CARE ABOUT SAFETY
EMERGENCY LIGHTING

Gamma:

ILLUMINAZIONE EMERGENZA A LED



LOVATO N 3
ILLUMINAZIONE EMERGENZA
A LED

p. 6



LOVATO P 3
ILLUMINAZIONE EMERGENZA
A LED

p. 9



AXN 3
ILLUMINAZIONE EMERGENZA
A LED

p. 13



AXP 3
ILLUMINAZIONE EMERGENZA
A LED

p. 16



LOVATO II
ILLUMINAZIONE EMERGENZA
A LED

p. 20



LOVATO P
ILLUMINAZIONE EMERGENZA
A LED

p. 23



AXN
ILLUMINAZIONE EMERGENZA
A LED

p. 27



AXP
ILLUMINAZIONE EMERGENZA
A LED

p. 30



MICRO SPOT
ILLUMINAZIONE EMERGENZA
A LED

p. 33



MICRO SPOT Round
ILLUMINAZIONE EMERGENZA
A LED

p. 36



MICRO SPOT Square
ILLUMINAZIONE EMERGENZA
A LED

p. 39



EYE LED Round
ILLUMINAZIONE EMERGENZA
A LED

p. 42

Gamma:

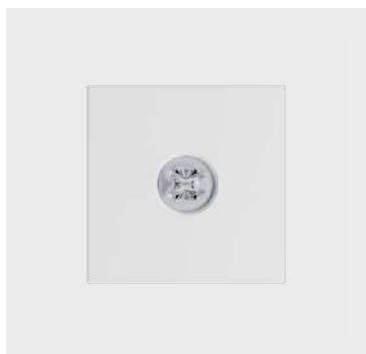

EYE LED Square p. 45
ILLUMINAZIONE EMERGENZA
A LED



TEY p. 48
ILLUMINAZIONE EMERGENZA
A LED



MX p. 50
ILLUMINAZIONE EMERGENZA
A LED



OUTDOOR LED p. 52
ILLUMINAZIONE EMERGENZA
A LED

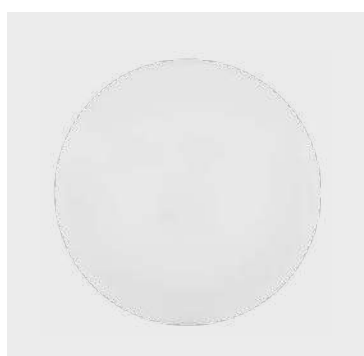

EDGE R p. 54
ILLUMINAZIONE EMERGENZA
A LED

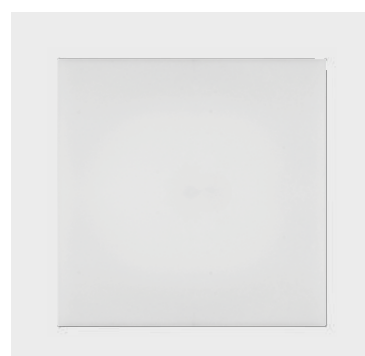

EDGE S p. 57
ILLUMINAZIONE EMERGENZA
A LED



HELIOS LED p. 61
ILLUMINAZIONE EMERGENZA
A LED



EXIT S p. 70
ILLUMINAZIONE EMERGENZA
A LED



EXIT M p. 74
ILLUMINAZIONE EMERGENZA
A LED



EXIT L p. 77
ILLUMINAZIONE EMERGENZA
A LED



WONDER p. 86
ILLUMINAZIONE EMERGENZA
A LED

Gamma:

APPARECCHI DI SEGNALAZIONE A LED



HELIOS LED
APPARECCHI DI SEGNALAZIONE
A LED SEGNALAZIONE A LED p. 64



HELIOS DS LED
APPARECCHI DI SEGNALAZIONE
A LED SEGNALAZIONE A LED p. 66



EXIT S
APPARECCHI DI SEGNALAZIONE
A LED SEGNALAZIONE A LED p. 73



ARROW N
APPARECCHI DI SEGNALAZIONE
A LED SEGNALAZIONE A LED p. 90



ARROW P
APPARECCHI DI SEGNALAZIONE
A LED SEGNALAZIONE A LED p. 92



INFINITY II B
APPARECCHI DI SEGNALAZIONE
A LED SEGNALAZIONE A LED p. 96



INFINITY II AC
APPARECCHI DI SEGNALAZIONE
A LED SEGNALAZIONE A LED p. 98



INFINITY II AW
APPARECCHI DI SEGNALAZIONE
A LED SEGNALAZIONE A LED p. 100



INFINITY II AL
APPARECCHI DI SEGNALAZIONE
A LED SEGNALAZIONE A LED p. 102



SK-8
APPARECCHI DI SEGNALAZIONE
A LED SEGNALAZIONE A LED p. 105



ESCAPE ALU B
APPARECCHI DI SEGNALAZIONE
A LED SEGNALAZIONE A LED p. 108

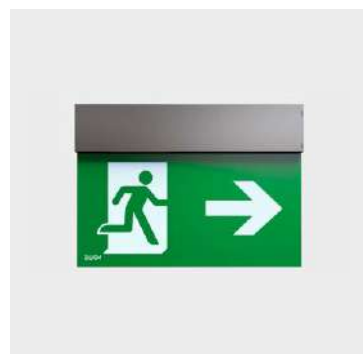

ESCAPE ALU AC
APPARECCHI DI SEGNALAZIONE
A LED SEGNALAZIONE A LED p. 110

Gamma:



ESCAPE ALU AL
APPARECCHI DI SEGNALAZIONE
A LED SEGNALAZIONE A LED p. 112



TWINS
APPARECCHI DI SEGNALAZIONE
A LED SEGNALAZIONE A LED p. 115



PLEXI LED
APPARECCHI DI SEGNALAZIONE
A LED SEGNALAZIONE A LED p. 119



CUBE
APPARECCHI DI SEGNALAZIONE
A LED SEGNALAZIONE A LED p. 121



PITTOGRAMMI
p. 124

CENTRAL BATTERY SYSTEM



FZLV II
p. 128



SPS
p. 128



RUBIC UNA
p. 128

LOVATO N 3



AC
220-240V
50-60Hz

DC
176-275V

DC
24V

DC
48V

LED

IP20

IK06

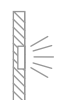

MATERIALI

Corpo Bianco, Grigio o Nero in polycarbonato

MONTAGGIO

Superficie
Opzione incasso ⁽¹⁾

ALIMENTAZIONE

Autonoma – 220 - 240VAC/50 - 60Hz
Central battery – 220 - 240VAC/50 - 60Hz; 176 - 275VDC
Central battery FZLV II – 48VDC *
Central battery FZLV – 24VDC *

SORGENTE LUMINOSA

1W, 2W, LED
Ottica: A – wall • O – open area • U – universale • R – vie di fuga
• R1 – vie di fuga • R2 – vie di fuga

RICARICA

Premium: max. 12h; charger a risparmio energetico

AUTONOMIA E BATTERIE

Premium: 1h o 3h, LiFePO₄ 3,2V batteria

CLASSE

II o III

GRADO IP & IK

IP20, IK06

TEMPERATURA

Autonoma: t_a: 0°C ÷ 40°C
Central battery: t_a: 0°C ÷ 50°C

OPZIONI

SE – Solo emergenza • SA – sempre accesa • AT – autotest • PT – pulsante di test
• CB – central battery • Versioni central test RUBIC o alimentazione e controllo centralizzato *

INFORMAZIONI

LED indicazione stato alimentazione e ricarica batteria • Protezione contro scarica profonda
• Classe di isolamento III per versione FZLV e FZLV2 • ⁽¹⁾ vedi accessori per montaggio a incasso

* su richiesta

DIMENSIONI [mm]

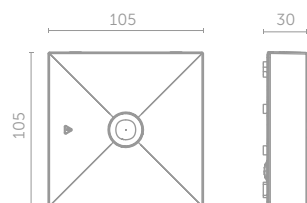

	CODICE ORDINE	LED SPOT LOVATO N 3	LISTINO
		IP20	
PREMIUM	LV3N/A/1W/B/1/SE/X/WH	LOVATO N 3.0 Ottica Wall 1W LED 250 lm PREMIUM IP20 1h autonomia, SE, colore Bianco	71,02 €
	LV3N/A/1W/B/3/SE/X/WH	LOVATO N 3.0 Ottica Wall 1W LED 200 lm PREMIUM IP20 3h autonomia, SE, colore Bianco	77,21 €
	LV3N/A/2W/B/1/SE/X/WH	LOVATO N 3.0 Ottica Wall 2W LED 380 lm PREMIUM IP20 1h autonomia, SE, colore Bianco	80,29 €
	LV3N/A/2W/B/3/SE/X/WH	LOVATO N 3.0 Ottica Wall 2W LED 310 lm PREMIUM IP20 3h autonomia, SE, colore Bianco	92,65 €
	LV3N/A/1W/B/1/SA/X/WH	LOVATO N 3.0 Ottica Wall 1W LED 250 lm PREMIUM IP20 1h autonomia, SE + SA, colore Bianco	78,74 €
	LV3N/A/1W/B/3/SA/X/WH	LOVATO N 3.0 Ottica Wall 1W LED 200 lm PREMIUM IP20 3h autonomia, SE + SA, colore Bianco	84,93 €
	LV3N/A/2W/B/1/SA/X/WH	LOVATO N 3.0 Ottica Wall 2W LED 380 lm PREMIUM IP20 1h autonomia, SE + SA, colore Bianco	88,01 €
	LV3N/A/2W/B/3/SA/X/WH	LOVATO N 3.0 Ottica Wall 2W LED 310 lm PREMIUM IP20 3h autonomia, SE + SA, colore Bianco	100,37 €
	LV3N/O/1W/B/1/SE/X/WH	LOVATO N 3.0 Ottica open area 1W LED 250 lm PREMIUM IP20 1h autonomia, SE, colore Bianco	71,02 €
	LV3N/O/1W/B/3/SE/X/WH	LOVATO N 3.0 Ottica open area 1W LED 200 lm PREMIUM IP20 3h autonomia, SE, colore Bianco	77,21 €
	LV3N/O/2W/B/1/SE/X/WH	LOVATO N 3.0 Ottica open area 2W LED 380 lm PREMIUM IP20 1h autonomia, SE, colore Bianco	80,29 €
	LV3N/O/2W/B/3/SE/X/WH	LOVATO N 3.0 Ottica open area 2W LED 310 lm PREMIUM IP20 3h autonomia, SE, colore Bianco	92,65 €
	LV3N/O/1W/B/1/SA/X/WH	LOVATO N 3.0 Ottica open area 1W LED 250 lm PREMIUM IP20 1h autonomia, SE + SA, colore Bianco	78,74 €
	LV3N/O/1W/B/3/SA/X/WH	LOVATO N 3.0 Ottica open area 1W LED 200 lm PREMIUM IP20 3h autonomia, SE + SA, colore Bianco	84,93 €
	LV3N/O/2W/B/1/SA/X/WH	LOVATO N 3.0 Ottica open area 2W LED 380 lm PREMIUM IP20 1h autonomia, SE + SA, colore Bianco	88,01 €
	LV3N/O/2W/B/3/SA/X/WH	LOVATO N 3.0 Ottica open area 2W LED 310 lm PREMIUM IP20 3h autonomia, SE + SA, colore Bianco	100,37 €
	LV3N/U/1W/B/1/SE/X/WH	LOVATO N 3.0 con Ottica Universale 1W LED 250 lm PREMIUM IP20 1h autonomia, SE, colore Bianco	71,02 €
	LV3N/U/1W/B/3/SE/X/WH	LOVATO N 3.0 con Ottica Universale 1W LED 200 lm PREMIUM IP20 3h autonomia, SE, colore Bianco	77,21 €
	LV3N/U/2W/B/1/SE/X/WH	LOVATO N 3.0 con Ottica Universale 2W LED 380 lm PREMIUM IP20 1h autonomia, SE, colore Bianco	80,29 €
	LV3N/U/2W/B/3/SE/X/WH	LOVATO N 3.0 con Ottica Universale 2W LED 310 lm PREMIUM IP20 3h autonomia, SE, colore Bianco	92,65 €
	LV3N/U/1W/B/1/SA/X/WH	LOVATO N 3.0 con Ottica Universale 1W LED 250 lm PREMIUM IP20 1h autonomia, SE + SA, colore Bianco	78,74 €
	LV3N/U/1W/B/3/SA/X/WH	LOVATO N 3.0 con Ottica Universale 1W LED 200 lm PREMIUM IP20 3h autonomia, SE + SA, colore Bianco	84,93 €
	LV3N/U/2W/B/1/SA/X/WH	LOVATO N 3.0 con Ottica Universale 2W LED 380 lm PREMIUM IP20 1h autonomia, SE + SA, colore Bianco	88,01 €
	LV3N/U/2W/B/3/SA/X/WH	LOVATO N 3.0 con Ottica Universale 2W LED 310 lm PREMIUM IP20 3h autonomia, SE + SA, colore Bianco	100,37 €
	LV3N/R/1W/B/1/SE/X/WH	LOVATO N 3.0 Ottica per vie di Fuga 1W LED 250 lm PREMIUM IP20 1h autonomia, SE, colore Bianco	71,02 €
	LV3N/R/1W/B/3/SE/X/WH	LOVATO N 3.0 Ottica per vie di Fuga 1W LED 200 lm PREMIUM IP20 3h autonomia, SE, colore Bianco	77,21 €
	LV3N/R/2W/B/1/SE/X/WH	LOVATO N 3.0 Ottica per vie di Fuga 2W LED 380 lm PREMIUM IP20 1h autonomia, SE, colore Bianco	80,29 €
	LV3N/R/2W/B/3/SE/X/WH	LOVATO N 3.0 Ottica per vie di Fuga 2W LED 310 lm PREMIUM IP20 3h autonomia, SE, colore Bianco	92,65 €
	LV3N/R/1W/B/1/SA/X/WH	LOVATO N 3.0 Ottica per vie di Fuga 1W LED 250 lm PREMIUM IP20 1h autonomia, SE + SA, colore Bianco	78,74 €
	LV3N/R/1W/B/3/SA/X/WH	LOVATO N 3.0 Ottica per vie di Fuga 1W LED 200 lm PREMIUM IP20 3h autonomia, SE + SA, colore Bianco	84,93 €
LV3N/R/2W/B/1/SA/X/WH	LOVATO N 3.0 Ottica per vie di Fuga 2W LED 380 lm PREMIUM IP20 1h autonomia, SE + SA, colore Bianco	88,01 €	
LV3N/R/2W/B/3/SA/X/WH	LOVATO N 3.0 Ottica per vie di Fuga 2W LED 310 lm PREMIUM IP20 3h autonomia, SE + SA, colore Bianco	100,37 €	

	CODICE ORDINE	LED SPOT LOVATO N 3	LISTINO
		IP20	
PREMIUM CON AUTOTEST	LV3N/A/1W/B/1/SE/AT/WH	LOVATO N 3.0 Ottica Wall 1W LED 250 lm PREMIUM IP20 1h autonomia, SE, con AUTOTEST, colore Bianco	86,46 €
	LV3N/A/1W/B/3/SE/AT/WH	LOVATO N 3.0 Ottica Wall 1W LED 200 lm PREMIUM IP20 3h autonomia, SE, con AUTOTEST, colore Bianco	92,65 €
	LV3N/A/2W/B/1/SE/AT/WH	LOVATO N 3.0 Ottica Wall 2W LED 380 lm PREMIUM IP20 1h autonomia, SE, con AUTOTEST, colore Bianco	95,73 €
	LV3N/A/2W/B/3/SE/AT/WH	LOVATO N 3.0 Ottica Wall 2W LED 310 lm PREMIUM IP20 3h autonomia, SE, con AUTOTEST, colore Bianco	108,07 €
	LV3N/A/1W/B/1/SA/AT/WH	LOVATO N 3.0 Ottica Wall 1W LED 250 lm PREMIUM IP20 1h autonomia, SE + SA, con AUTOTEST, colore Bianco	94,18 €
	LV3N/A/1W/B/3/SA/AT/WH	LOVATO N 3.0 Ottica Wall 1W LED 200 lm PREMIUM IP20 3h autonomia, SE + SA, con AUTOTEST, colore Bianco	100,37 €
	LV3N/A/2W/B/1/SA/AT/WH	LOVATO N 3.0 Ottica Wall 2W LED 380 lm PREMIUM IP20 1h autonomia, SE + SA, con AUTOTEST, colore Bianco	103,45 €
	LV3N/A/2W/B/3/SA/AT/WH	LOVATO N 3.0 Ottica Wall 2W LED 310 lm PREMIUM IP20 3h autonomia, SE + SA, con AUTOTEST, colore Bianco	115,79 €
	LV3N/O/1W/B/1/SE/AT/WH	LOVATO N 3.0 Ottica open area 1W LED 250 lm PREMIUM IP20 1h autonomia, SE, con AUTOTEST, colore Bianco	86,46 €
	LV3N/O/1W/B/3/SE/AT/WH	LOVATO N 3.0 Ottica open area 1W LED 200 lm PREMIUM IP20 3h autonomia, SE, con AUTOTEST, colore Bianco	92,65 €
	LV3N/O/2W/B/1/SE/AT/WH	LOVATO N 3.0 Ottica open area 2W LED 380 lm PREMIUM IP20 1h autonomia, SE, con AUTOTEST, colore Bianco	95,73 €
	LV3N/O/2W/B/3/SE/AT/WH	LOVATO N 3.0 Ottica open area 2W LED 310 lm PREMIUM IP20 3h autonomia, SE, con AUTOTEST, colore Bianco	108,07 €
	LV3N/O/1W/B/1/SA/AT/WH	LOVATO N 3.0 Ottica open area 1W LED 250 lm PREMIUM IP20 1h autonomia, SE + SA, con AUTOTEST, colore Bianco	94,18 €
	LV3N/O/1W/B/3/SA/AT/WH	LOVATO N 3.0 Ottica open area 1W LED 200 lm PREMIUM IP20 3h autonomia, SE + SA, con AUTOTEST, colore Bianco	100,37 €
	LV3N/O/2W/B/1/SA/AT/WH	LOVATO N 3.0 Ottica open area 2W LED 380 lm PREMIUM IP20 1h autonomia, SE + SA, con AUTOTEST, colore Bianco	103,45 €
	LV3N/O/2W/B/3/SA/AT/WH	LOVATO N 3.0 Ottica open area 2W LED 310 lm PREMIUM IP20 3h autonomia, SE + SA, con AUTOTEST, colore Bianco	115,79 €
	LV3N/U/1W/B/1/SE/AT/WH	LOVATO N 3.0 con Ottica Universale 1W LED 250 lm PREMIUM IP20 1h autonomia, SE, con AUTOTEST, colore Bianco	86,46 €
	LV3N/U/1W/B/3/SE/AT/WH	LOVATO N 3.0 con Ottica Universale 1W LED 200 lm PREMIUM IP20 3h autonomia, SE, con AUTOTEST, colore Bianco	92,65 €
	LV3N/U/2W/B/1/SE/AT/WH	LOVATO N 3.0 con Ottica Universale 2W LED 380 lm PREMIUM IP20 1h autonomia, SE, con AUTOTEST, colore Bianco	95,73 €
	LV3N/U/2W/B/3/SE/AT/WH	LOVATO N 3.0 con Ottica Universale 2W LED 310 lm PREMIUM IP20 3h autonomia, SE, con AUTOTEST, colore Bianco	108,07 €
	LV3N/U/1W/B/1/SA/AT/WH	LOVATO N 3.0 con Ottica Universale 1W LED 250 lm PREMIUM IP20 1h autonomia, SE + SA, con AUTOTEST, colore Bianco	94,18 €
	LV3N/U/1W/B/3/SA/AT/WH	LOVATO N 3.0 con Ottica Universale 1W LED 200 lm PREMIUM IP20 3h autonomia, SE + SA, con AUTOTEST, colore Bianco	100,37 €
	LV3N/U/2W/B/1/SA/AT/WH	LOVATO N 3.0 con Ottica Universale 2W LED 380 lm PREMIUM IP20 1h autonomia, SE + SA, con AUTOTEST, colore Bianco	103,45 €
	LV3N/U/2W/B/3/SA/AT/WH	LOVATO N 3.0 con Ottica Universale 2W LED 310 lm PREMIUM IP20 3h autonomia, SE + SA, con AUTOTEST, colore Bianco	115,79 €
	LV3N/R/1W/B/1/SE/AT/WH	LOVATO N 3.0 Ottica per vie di Fuga 1W LED 250 lm PREMIUM IP20 1h autonomia, SE, con AUTOTEST, colore Bianco	86,46 €
	LV3N/R/1W/B/3/SE/AT/WH	LOVATO N 3.0 Ottica per vie di Fuga 1W LED 200 lm PREMIUM IP20 3h autonomia, SE, con AUTOTEST, colore Bianco	92,65 €
	LV3N/R/2W/B/1/SE/AT/WH	LOVATO N 3.0 Ottica per vie di Fuga 2W LED 380 lm PREMIUM IP20 1h autonomia, SE, con AUTOTEST, colore Bianco	95,73 €
	LV3N/R/2W/B/3/SE/AT/WH	LOVATO N 3.0 Ottica per vie di Fuga 2W LED 310 lm PREMIUM IP20 3h autonomia, SE, con AUTOTEST, colore Bianco	108,07 €
	LV3N/R/1W/B/1/SA/AT/WH	LOVATO N 3.0 Ottica per vie di Fuga 1W LED 250 lm PREMIUM IP20 1h autonomia, SE + SA, con AUTOTEST, colore Bianco	94,18 €
	LV3N/R/1W/B/3/SA/AT/WH	LOVATO N 3.0 Ottica per vie di Fuga 1W LED 200 lm PREMIUM IP20 3h autonomia, SE + SA, con AUTOTEST, colore Bianco	100,37 €
LV3N/R/2W/B/1/SA/AT/WH	LOVATO N 3.0 Ottica per vie di Fuga 2W LED 380 lm PREMIUM IP20 1h autonomia, SE + SA, con AUTOTEST, colore Bianco	103,45 €	
LV3N/R/2W/B/3/SA/AT/WH	LOVATO N 3.0 Ottica per vie di Fuga 2W LED 310 lm PREMIUM IP20 3h autonomia, SE + SA, con AUTOTEST, colore Bianco	115,79 €	

LEGGENDA:

SE	Emergenza	E	Apparecchio autonomo con elettronica tipo STANDARD
SA	Emergenza + SA	C	Apparecchio autonomo con elettronica tipo STANDARD
AT	autotest	B	Apparecchio autonomo con elettronica tipo PREMIUM
CB	central battery	F	Apparecchio NON AUTONOMO - Alimentazione centralizzata

LOVATO P 3



AC
220-240V
50-60Hz

DC
176-275V

DC
24V

DC
48V

LED

IP20

IK07



MATERIALI

Corpo Bianco, Grigio o Nero in policarbonato

MONTAGGIO

Incasso

ALIMENTAZIONE

Autonoma – 220 - 240VAC/50 - 60Hz
Central battery – 220 - 240VAC/50 - 60Hz; 176 - 275VDC
Central battery FZLV II – 48VDC *
Central battery FZLV – 24VDC *

SORGENTE LUMINOSA

1W, 2W, LED
Ottica: A – wall • O – open area • U – universale • R – vie di fuga
• R1 – vie di fuga • R2 – vie di fuga

RICARICA

Premium: max. 12h; charger a risparmio energetico

AUTONOMIA E BATTERIE

Premium: 1h o 3h, LiFePO₄ 3,2V batteria

CLASSE

II o III

GRADO IP & IK

IP20, IK07

TEMPERATURA

Autonoma: t_a: 0°C ÷ 40°C
Central battery: t_a: 0°C ÷ 50°C

OPZIONI

SE – Solo emergenza • SA – sempre accesa • AT – autotest • PT – pulsante di test
• CB – central battery • Versioni central test RUBIC o alimentazione e controllo centralizzato *

INFORMAZIONI

LED indicazione stato alimentazione e ricarica batteria • Protezione contro scarica profonda
• Classe di isolamento III per versione FZLV e FZLV2

* su richiesta

DIMENSIONI [mm]

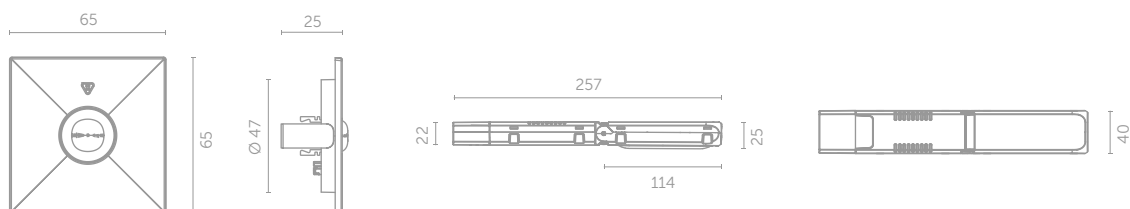

	CODICE ORDINE	LED SPOT LOVATO P 3	LISTINO
		IP20	
PREMIUM	LV3P/A/1W/B/1/SE/X/WH	LOVATO P 3.0 Ottica Wall 1W LED 250 lm PREMIUM IP20 1h autonomia, SE, colore Bianco	71,02 €
	LV3P/A/1W/B/3/SE/X/WH	LOVATO P 3.0 Ottica Wall 1W LED 200 lm PREMIUM IP20 3h autonomia, SE, colore Bianco	77,21 €
	LV3P/A/2W/B/1/SE/X/WH	LOVATO P 3.0 Ottica Wall 2W LED 380 lm PREMIUM IP20 1h autonomia, SE, colore Bianco	80,29 €
	LV3P/A/2W/B/3/SE/X/WH	LOVATO P 3.0 Ottica Wall 2W LED 310 lm PREMIUM IP20 3h autonomia, SE, colore Bianco	92,65 €
	LV3P/A/1W/B/1/SA/X/WH	LOVATO P 3.0 Ottica Wall 1W LED 250 lm PREMIUM IP20 1h autonomia, SE + SA, colore Bianco	78,74 €
	LV3P/A/1W/B/3/SA/X/WH	LOVATO P 3.0 Ottica Wall 1W LED 200 lm PREMIUM IP20 3h autonomia, SE + SA, colore Bianco	84,93 €
	LV3P/A/2W/B/1/SA/X/WH	LOVATO P 3.0 Ottica Wall 2W LED 380 lm PREMIUM IP20 1h autonomia, SE + SA, colore Bianco	88,01 €
	LV3P/A/2W/B/3/SA/X/WH	LOVATO P 3.0 Ottica Wall 2W LED 310 lm PREMIUM IP20 3h autonomia, SE + SA, colore Bianco	100,37 €
	LV3P/O/1W/B/1/SE/X/WH	LOVATO P 3.0 Ottica open area 1W LED 250 lm PREMIUM IP20 1h autonomia, SE, colore Bianco	71,02 €
	LV3P/O/1W/B/3/SE/X/WH	LOVATO P 3.0 Ottica open area 1W LED 200 lm PREMIUM IP20 3h autonomia, SE, colore Bianco	77,21 €
	LV3P/O/2W/B/1/SE/X/WH	LOVATO P 3.0 Ottica open area 2W LED 380 lm PREMIUM IP20 1h autonomia, SE, colore Bianco	80,29 €
	LV3P/O/2W/B/3/SE/X/WH	LOVATO P 3.0 Ottica open area 2W LED 310 lm PREMIUM IP20 3h autonomia, SE, colore Bianco	92,65 €
	LV3P/O/1W/B/1/SA/X/WH	LOVATO P 3.0 Ottica open area 1W LED 250 lm PREMIUM IP20 1h autonomia, SE + SA, colore Bianco	78,74 €
	LV3P/O/1W/B/3/SA/X/WH	LOVATO P 3.0 Ottica open area 1W LED 200 lm PREMIUM IP20 3h autonomia, SE + SA, colore Bianco	84,93 €
	LV3P/O/2W/B/1/SA/X/WH	LOVATO P 3.0 Ottica open area 2W LED 380 lm PREMIUM IP20 1h autonomia, SE + SA, colore Bianco	88,01 €
	LV3P/O/2W/B/3/SA/X/WH	LOVATO P 3.0 Ottica open area 2W LED 310 lm PREMIUM IP20 3h autonomia, SE + SA, colore Bianco	100,37 €
	LV3P/U/1W/B/1/SE/X/WH	LOVATO P 3.0 con Ottica Universale 1W LED 250 lm PREMIUM IP20 1h autonomia, SE, colore Bianco	71,02 €
	LV3P/U/1W/B/3/SE/X/WH	LOVATO P 3.0 con Ottica Universale 1W LED 200 lm PREMIUM IP20 3h autonomia, SE, colore Bianco	77,21 €
	LV3P/U/2W/B/1/SE/X/WH	LOVATO P 3.0 con Ottica Universale 2W LED 380 lm PREMIUM IP20 1h autonomia, SE, colore Bianco	80,29 €
	LV3P/U/2W/B/3/SE/X/WH	LOVATO P 3.0 con Ottica Universale 2W LED 310 lm PREMIUM IP20 3h autonomia, SE, colore Bianco	92,65 €
	LV3P/U/1W/B/1/SA/X/WH	LOVATO P 3.0 con Ottica Universale 1W LED 250 lm PREMIUM IP20 1h autonomia, SE + SA, colore Bianco	78,74 €
	LV3P/U/1W/B/3/SA/X/WH	LOVATO P 3.0 con Ottica Universale 1W LED 200 lm PREMIUM IP20 3h autonomia, SE + SA, colore Bianco	84,93 €
	LV3P/U/2W/B/1/SA/X/WH	LOVATO P 3.0 con Ottica Universale 2W LED 380 lm PREMIUM IP20 1h autonomia, SE + SA, colore Bianco	88,01 €
	LV3P/U/2W/B/3/SA/X/WH	LOVATO P 3.0 con Ottica Universale 2W LED 310 lm PREMIUM IP20 3h autonomia, SE + SA, colore Bianco	100,37 €
	LV3P/R/1W/B/1/SE/X/WH	LOVATO P 3.0 Ottica per vie di Fuga 1W LED 250 lm PREMIUM IP20 1h autonomia, SE, colore Bianco	71,02 €
	LV3P/R/1W/B/3/SE/X/WH	LOVATO P 3.0 Ottica per vie di Fuga 1W LED 200 lm PREMIUM IP20 3h autonomia, SE, colore Bianco	77,21 €
	LV3P/R/2W/B/1/SE/X/WH	LOVATO P 3.0 Ottica per vie di Fuga 2W LED 380 lm PREMIUM IP20 1h autonomia, SE, colore Bianco	80,29 €
	LV3P/R/2W/B/3/SE/X/WH	LOVATO P 3.0 Ottica per vie di Fuga 2W LED 310 lm PREMIUM IP20 3h autonomia, SE, colore Bianco	92,65 €
	LV3P/R/1W/B/1/SA/X/WH	LOVATO P 3.0 Ottica per vie di Fuga 1W LED 250 lm PREMIUM IP20 1h autonomia, SE + SA, colore Bianco	78,74 €
	LV3P/R/1W/B/3/SA/X/WH	LOVATO P 3.0 Ottica per vie di Fuga 1W LED 200 lm PREMIUM IP20 3h autonomia, SE + SA, colore Bianco	84,93 €
LV3P/R/2W/B/1/SA/X/WH	LOVATO P 3.0 Ottica per vie di Fuga 2W LED 380 lm PREMIUM IP20 1h autonomia, SE + SA, colore Bianco	88,01 €	
LV3P/R/2W/B/3/SA/X/WH	LOVATO P 3.0 Ottica per vie di Fuga 2W LED 310 lm PREMIUM IP20 3h autonomia, SE + SA, colore Bianco	100,37 €	

	CODICE ORDINE	LED SPOT LOVATO P 3	LISTINO
		IP20	
PREMIUM CON AUTOTEST	LV3P/A/1W/B/1/SE/AT/WH	LOVATO P 3.0 Ottica Wall 1W LED 250 lm PREMIUM IP20 1h autonomia, SE, con AUTOTEST, colore Bianco	86,46 €
	LV3P/A/1W/B/3/SE/AT/WH	LOVATO P 3.0 Ottica Wall 1W LED 200 lm PREMIUM IP20 3h autonomia, SE, con AUTOTEST, colore Bianco	92,65 €
	LV3P/A/2W/B/1/SE/AT/WH	LOVATO P 3.0 Ottica Wall 2W LED 380 lm PREMIUM IP20 1h autonomia, SE, con AUTOTEST, colore Bianco	95,73 €
	LV3P/A/2W/B/3/SE/AT/WH	LOVATO P 3.0 Ottica Wall 2W LED 310 lm PREMIUM IP20 3h autonomia, SE, con AUTOTEST, colore Bianco	108,07 €
	LV3P/A/1W/B/1/SA/AT/WH	LOVATO P 3.0 Ottica Wall 1W LED 250 lm PREMIUM IP20 1h autonomia, SE + SA, con AUTOTEST, colore Bianco	94,18 €
	LV3P/A/1W/B/3/SA/AT/WH	LOVATO P 3.0 Ottica Wall 1W LED 200 lm PREMIUM IP20 3h autonomia, SE + SA, con AUTOTEST, colore Bianco	100,37 €
	LV3P/A/2W/B/1/SA/AT/WH	LOVATO P 3.0 Ottica Wall 2W LED 380 lm PREMIUM IP20 1h autonomia, SE + SA, con AUTOTEST, colore Bianco	103,45 €
	LV3P/A/2W/B/3/SA/AT/WH	LOVATO P 3.0 Ottica Wall 2W LED 310 lm PREMIUM IP20 3h autonomia, SE + SA, con AUTOTEST, colore Bianco	115,79 €
	LV3P/O/1W/B/1/SE/AT/WH	LOVATO P 3.0 Ottica open area 1W LED 250 lm PREMIUM IP20 1h autonomia, SE, con AUTOTEST, colore Bianco	86,46 €
	LV3P/O/1W/B/3/SE/AT/WH	LOVATO P 3.0 Ottica open area 1W LED 200 lm PREMIUM IP20 3h autonomia, SE, con AUTOTEST, colore Bianco	92,65 €
	LV3P/O/2W/B/1/SE/AT/WH	LOVATO P 3.0 Ottica open area 2W LED 380 lm PREMIUM IP20 1h autonomia, SE, con AUTOTEST, colore Bianco	95,73 €
	LV3P/O/2W/B/3/SE/AT/WH	LOVATO P 3.0 Ottica open area 2W LED 310 lm PREMIUM IP20 3h autonomia, SE, con AUTOTEST, colore Bianco	108,07 €
	LV3P/O/1W/B/1/SA/AT/WH	LOVATO P 3.0 Ottica open area 1W LED 250 lm PREMIUM IP20 1h autonomia, SE + SA, con AUTOTEST, colore Bianco	94,18 €
	LV3P/O/1W/B/3/SA/AT/WH	LOVATO P 3.0 Ottica open area 1W LED 200 lm PREMIUM IP20 3h autonomia, SE + SA, con AUTOTEST, colore Bianco	100,37 €
	LV3P/O/2W/B/1/SA/AT/WH	LOVATO P 3.0 Ottica open area 2W LED 380 lm PREMIUM IP20 1h autonomia, SE + SA, con AUTOTEST, colore Bianco	103,45 €
	LV3P/O/2W/B/3/SA/AT/WH	LOVATO P 3.0 Ottica open area 2W LED 310 lm PREMIUM IP20 3h autonomia, SE + SA, con AUTOTEST, colore Bianco	115,79 €
	LV3P/U/1W/B/1/SE/AT/WH	LOVATO P 3.0 con Ottica Universale 1W LED 250 lm PREMIUM IP20 1h autonomia, SE, con AUTOTEST, colore Bianco	86,46 €
	LV3P/U/1W/B/3/SE/AT/WH	LOVATO P 3.0 con Ottica Universale 1W LED 200 lm PREMIUM IP20 3h autonomia, SE, con AUTOTEST, colore Bianco	92,65 €
	LV3P/U/2W/B/1/SE/AT/WH	LOVATO P 3.0 con Ottica Universale 2W LED 380 lm PREMIUM IP20 1h autonomia, SE, con AUTOTEST, colore Bianco	95,73 €
	LV3P/U/2W/B/3/SE/AT/WH	LOVATO P 3.0 con Ottica Universale 2W LED 310 lm PREMIUM IP20 3h autonomia, SE, con AUTOTEST, colore Bianco	108,07 €
	LV3P/U/1W/B/1/SA/AT/WH	LOVATO P 3.0 con Ottica Universale 1W LED 250 lm PREMIUM IP20 1h autonomia, SE + SA, con AUTOTEST, colore Bianco	94,18 €
	LV3P/U/1W/B/3/SA/AT/WH	LOVATO P 3.0 con Ottica Universale 1W LED 200 lm PREMIUM IP20 3h autonomia, SE + SA, con AUTOTEST, colore Bianco	100,37 €
	LV3P/U/2W/B/1/SA/AT/WH	LOVATO P 3.0 con Ottica Universale 2W LED 380 lm PREMIUM IP20 1h autonomia, SE + SA, con AUTOTEST, colore Bianco	103,45 €
	LV3P/U/2W/B/3/SA/AT/WH	LOVATO P 3.0 con Ottica Universale 2W LED 310 lm PREMIUM IP20 3h autonomia, SE + SA, con AUTOTEST, colore Bianco	115,79 €
	LV3P/R/1W/B/1/SE/AT/WH	LOVATO P 3.0 Ottica per vie di Fuga 1W LED 250 lm PREMIUM IP20 1h autonomia, SE, con AUTOTEST, colore Bianco	86,46 €
	LV3P/R/1W/B/3/SE/AT/WH	LOVATO P 3.0 Ottica per vie di Fuga 1W LED 200 lm PREMIUM IP20 3h autonomia, SE, con AUTOTEST, colore Bianco	92,65 €
	LV3P/R/2W/B/1/SE/AT/WH	LOVATO P 3.0 Ottica per vie di Fuga 2W LED 380 lm PREMIUM IP20 1h autonomia, SE, con AUTOTEST, colore Bianco	95,73 €
	LV3P/R/2W/B/3/SE/AT/WH	LOVATO P 3.0 Ottica per vie di Fuga 2W LED 310 lm PREMIUM IP20 3h autonomia, SE, con AUTOTEST, colore Bianco	108,07 €
	LV3P/R/1W/B/1/SA/AT/WH	LOVATO P 3.0 Ottica per vie di Fuga 1W LED 250 lm PREMIUM IP20 1h autonomia, SE + SA, con AUTOTEST, colore Bianco	94,18 €
	LV3P/R/1W/B/3/SA/AT/WH	LOVATO P 3.0 Ottica per vie di Fuga 1W LED 200 lm PREMIUM IP20 3h autonomia, SE + SA, con AUTOTEST, colore Bianco	100,37 €
LV3P/R/2W/B/1/SA/AT/WH	LOVATO P 3.0 Ottica per vie di Fuga 2W LED 380 lm PREMIUM IP20 1h autonomia, SE + SA, con AUTOTEST, colore Bianco	103,45 €	
LV3P/R/2W/B/3/SA/AT/WH	LOVATO P 3.0 Ottica per vie di Fuga 2W LED 310 lm PREMIUM IP20 3h autonomia, SE + SA, con AUTOTEST, colore Bianco	115,79 €	

LEGGENDA:

SE	Emergenza	E	Apparecchio autonomo con elettronica tipo STANDARD
SA	Emergenza + SA	C	Apparecchio autonomo con elettronica tipo STANDARD
AT	autotest	B	Apparecchio autonomo con elettronica tipo PREMIUM
CB	central battery	F	Apparecchio NON AUTONOMO - Alimentazione centralizzata

LOVATO 3 accessori



ACCESSORIO PER INCASSO NEL CONTROSOFFITTO

CODICE: LV3N/REC/WH
LV3N/REC/GR
LV3N/REC/BL

DIMENSIONI [mm]

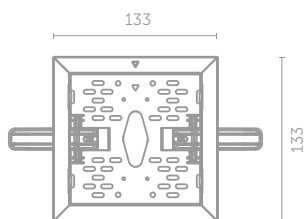

ADATTABILE A LOVATO N 3



SCATOLA PER MONTAGGIO IN SUPERFICIE CON INGRESSO CAVI LATERALE

CODICE: LV3N/BOX/WH
LV3N/BOX/GR
LV3N/BOX/BL

DIMENSIONI [mm]

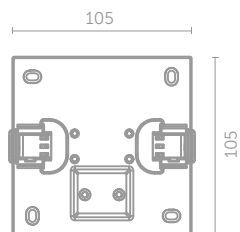

ADATTABILE A LOVATO N 3



AXN 3



AC
220-240V
50-60Hz

DC
176-275V

DC
24V

DC
48V

LED

IP20

IK06

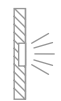
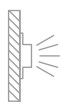

MATERIALI

Corpo Bianco, Grigio o Nero in policarbonato

MONTAGGIO

Superficie
Opzione incasso ⁽¹⁾

ALIMENTAZIONE

Autonoma – 220 - 240VAC/50 - 60Hz
Central battery – 220 - 240VAC/50 - 60Hz; 176 - 275VDC
Central battery FZLV II – 48VDC *
Central battery FZLV – 24VDC *

SORGENTE LUMINOSA

1W, 2W, LED
Ottica: A – wall • O – open area • U – universale • R – vie di fuga
• R1 – vie di fuga • R2 – vie di fuga

RICARICA

Premium: max. 12h; charger a risparmio energetico

AUTONOMIA E BATTERIE

Premium: 1h o 3h, LiFePO₄ 3,2V batteria

CLASSE

II o III

GRADO IP & IK

IP20, IK06

TEMPERATURA

Autonoma: t_a: 0°C ÷ 40°C **Central battery:** t_a: 0°C ÷ 50°C

OPZIONI

SE – Solo emergenza • SA – sempre accesa • AT – autotest • PT – pulsante di test
• CB – central battery • Versioni central test RUBIC o alimentazione e controllo centralizzato *

INFORMAZIONI

LED indicazione stato alimentazione e ricarica batteria • Protezione contro scarica profonda
• Classe di isolamento III per versione FZLV e FZLV2 • ⁽¹⁾ vedi accessori per montaggio a incasso

* su richiesta

DIMENSIONI [mm]

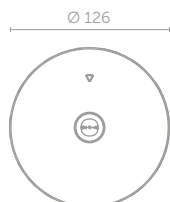

	CODICE ORDINE	AXN 3	LISTINO
		IP20	
STANDARD	AX3N/A/1W/B/1/SE/X/WH	AXN 3.0 Ottica Wall 1W LED 250 lm PREMIUM IP20 1h autonomia, SE, colore Bianco	71,02 €
	AX3N/A/1W/B/3/SE/X/WH	AXN 3.0 Ottica Wall 1W LED 200 lm PREMIUM IP20 3h autonomia, SE, colore Bianco	77,21 €
	AX3N/A/2W/B/1/SE/X/WH	AXN 3.0 Ottica Wall 2W LED 380 lm PREMIUM IP20 1h autonomia, SE, colore Bianco	80,29 €
	AX3N/A/2W/B/3/SE/X/WH	AXN 3.0 Ottica Wall 2W LED 310 lm PREMIUM IP20 3h autonomia, SE, colore Bianco	92,65 €
	AX3N/A/1W/B/1/SA/X/WH	AXN 3.0 Ottica Wall 1W LED 250 lm PREMIUM IP20 1h autonomia, SE + SA, colore Bianco	78,74 €
	AX3N/A/1W/B/3/SA/X/WH	AXN 3.0 Ottica Wall 1W LED 200 lm PREMIUM IP20 3h autonomia, SE + SA, colore Bianco	84,93 €
	AX3N/A/2W/B/1/SA/X/WH	AXN 3.0 Ottica Wall 2W LED 380 lm PREMIUM IP20 1h autonomia, SE + SA, colore Bianco	88,01 €
	AX3N/A/2W/B/3/SA/X/WH	AXN 3.0 Ottica Wall 2W LED 310 lm PREMIUM IP20 3h autonomia, SE + SA, colore Bianco	100,37 €
	AX3N/U/1W/B/1/SE/X/WH	AXN 3.0 con Ottica Universale 1W LED 250 lm PREMIUM IP20 1h autonomia, SE, colore Bianco	71,02 €
	AX3N/U/1W/B/3/SE/X/WH	AXN 3.0 con Ottica Universale 1W LED 200 lm PREMIUM IP20 3h autonomia, SE, colore Bianco	77,21 €
	AX3N/U/2W/B/1/SE/X/WH	AXN 3.0 con Ottica Universale 2W LED 380 lm PREMIUM IP20 1h autonomia, SE, colore Bianco	80,29 €
	AX3N/U/2W/B/3/SE/X/WH	AXN 3.0 con Ottica Universale 2W LED 310 lm PREMIUM IP20 3h autonomia, SE, colore Bianco	92,65 €
	AX3N/U/1W/B/1/SA/X/WH	AXN 3.0 con Ottica Universale 1W LED 250 lm PREMIUM IP20 1h autonomia, SE + SA, colore Bianco	78,74 €
	AX3N/U/1W/B/3/SA/X/WH	AXN 3.0 con Ottica Universale 1W LED 200 lm PREMIUM IP20 3h autonomia, SE + SA, colore Bianco	84,93 €
	AX3N/U/2W/B/1/SA/X/WH	AXN 3.0 con Ottica Universale 2W LED 380 lm PREMIUM IP20 1h autonomia, SE + SA, colore Bianco	88,01 €
	AX3N/U/2W/B/3/SA/X/WH	AXN 3.0 con Ottica Universale 2W LED 310 lm PREMIUM IP20 3h autonomia, SE + SA, colore Bianco	100,37 €
	AX3N/R/1W/B/1/SE/X/WH	AXN 3.0 Ottica per vie di Fuga 1W LED 250 lm PREMIUM IP20 1h autonomia, SE, colore Bianco	71,02 €
	AX3N/R/1W/B/3/SE/X/WH	AXN 3.0 Ottica per vie di Fuga 1W LED 200 lm PREMIUM IP20 3h autonomia, SE, colore Bianco	77,21 €
	AX3N/R/2W/B/1/SE/X/WH	AXN 3.0 Ottica per vie di Fuga 2W LED 380 lm PREMIUM IP20 1h autonomia, SE, colore Bianco	80,29 €
	AX3N/R/2W/B/3/SE/X/WH	AXN 3.0 Ottica per vie di Fuga 2W LED 310 lm PREMIUM IP20 3h autonomia, SE, colore Bianco	92,65 €
	AX3N/R/1W/B/1/SA/X/WH	AXN 3.0 Ottica per vie di Fuga 1W LED 250 lm PREMIUM IP20 1h autonomia, SE + SA, colore Bianco	78,74 €
	AX3N/R/1W/B/3/SA/X/WH	AXN 3.0 Ottica per vie di Fuga 1W LED 200 lm PREMIUM IP20 3h autonomia, SE + SA, colore Bianco	84,93 €
	AX3N/R/2W/B/1/SA/X/WH	AXN 3.0 Ottica per vie di Fuga 2W LED 380 lm PREMIUM IP20 1h autonomia, SE + SA, colore Bianco	88,01 €
	AX3N/R/2W/B/3/SA/X/WH	AXN 3.0 Ottica per vie di Fuga 2W LED 310 lm PREMIUM IP20 3h autonomia, SE + SA, colore Bianco	100,37 €
	AX3N/O/1W/B/1/SE/X/WH	AXN 3.0 Ottica open area 1W LED 250 lm PREMIUM IP20 1h autonomia, SE, colore Bianco	71,02 €
	AX3N/O/1W/B/3/SE/X/WH	AXN 3.0 Ottica open area 1W LED 200 lm PREMIUM IP20 3h autonomia, SE, colore Bianco	77,21 €
	AX3N/O/2W/B/1/SE/X/WH	AXN 3.0 Ottica open area 2W LED 380 lm PREMIUM IP20 1h autonomia, SE, colore Bianco	80,29 €
	AX3N/O/2W/B/3/SE/X/WH	AXN 3.0 Ottica open area 2W LED 310 lm PREMIUM IP20 3h autonomia, SE, colore Bianco	92,65 €
	AX3N/O/1W/B/1/SA/X/WH	AXN 3.0 Ottica open area 1W LED 250 lm PREMIUM IP20 1h autonomia, SE + SA, colore Bianco	78,74 €
	AX3N/O/1W/B/3/SA/X/WH	AXN 3.0 Ottica open area 1W LED 200 lm PREMIUM IP20 3h autonomia, SE + SA, colore Bianco	84,93 €
	AX3N/O/2W/B/1/SA/X/WH	AXN 3.0 Ottica open area 2W LED 380 lm PREMIUM IP20 1h autonomia, SE + SA, colore Bianco	88,01 €
	AX3N/O/2W/B/3/SA/X/WH	AXN 3.0 Ottica open area 2W LED 310 lm PREMIUM IP20 3h autonomia, SE + SA, colore Bianco	100,37 €

	CODICE ORDINE	AXN 3	LISTINO
		IP20	
PREMIUM CON AUTOTEST	AX3N/A/1W/B/1/SE/AT/WH	AXN 3.0 Ottica Wall 1W LED 250 lm PREMIUM IP20 1h autonomia, SE, con AUTOTEST, colore Bianco	86,46 €
	AX3N/A/1W/B/3/SE/AT/WH	AXN 3.0 Ottica Wall 1W LED 200 lm PREMIUM IP20 3h autonomia, SE, con AUTOTEST, colore Bianco	92,65 €
	AX3N/A/2W/B/1/SE/AT/WH	AXN 3.0 Ottica Wall 2W LED 380 lm PREMIUM IP20 1h autonomia, SE, con AUTOTEST, colore Bianco	95,73 €
	AX3N/A/2W/B/3/SE/AT/WH	AXN 3.0 Ottica Wall 2W LED 310 lm PREMIUM IP20 3h autonomia, SE, con AUTOTEST, colore Bianco	108,07 €
	AX3N/A/1W/B/1/SA/AT/WH	AXN 3.0 Ottica Wall 1W LED 250 lm PREMIUM IP20 1h autonomia, SE + SA, con AUTOTEST, colore Bianco	94,18 €
	AX3N/A/1W/B/3/SA/AT/WH	AXN 3.0 Ottica Wall 1W LED 200 lm PREMIUM IP20 3h autonomia, SE + SA, con AUTOTEST, colore Bianco	100,37 €
	AX3N/A/2W/B/1/SA/AT/WH	AXN 3.0 Ottica Wall 2W LED 380 lm PREMIUM IP20 1h autonomia, SE + SA, con AUTOTEST, colore Bianco	103,45 €
	AX3N/A/2W/B/3/SA/AT/WH	AXN 3.0 Ottica Wall 2W LED 310 lm PREMIUM IP20 3h autonomia, SE + SA, con AUTOTEST, colore Bianco	115,79 €
	AX3N/U/1W/B/1/SE/AT/WH	AXN 3.0 con Ottica Universale 1W LED 250 lm PREMIUM IP20 1h autonomia, SE, con AUTOTEST, colore Bianco	86,46 €
	AX3N/U/1W/B/3/SE/AT/WH	AXN 3.0 con Ottica Universale 1W LED 200 lm PREMIUM IP20 3h autonomia, SE, con AUTOTEST, colore Bianco	92,65 €
	AX3N/U/2W/B/1/SE/AT/WH	AXN 3.0 con Ottica Universale 2W LED 380 lm PREMIUM IP20 1h autonomia, SE, con AUTOTEST, colore Bianco	95,73 €
	AX3N/U/2W/B/3/SE/AT/WH	AXN 3.0 con Ottica Universale 2W LED 310 lm PREMIUM IP20 3h autonomia, SE, con AUTOTEST, colore Bianco	108,07 €
	AX3N/U/1W/B/1/SA/AT/WH	AXN 3.0 con Ottica Universale 1W LED 250 lm PREMIUM IP20 1h autonomia, SE + SA, con AUTOTEST, colore Bianco	94,18 €
	AX3N/U/1W/B/3/SA/AT/WH	AXN 3.0 con Ottica Universale 1W LED 200 lm PREMIUM IP20 3h autonomia, SE + SA, con AUTOTEST, colore Bianco	100,37 €
	AX3N/U/2W/B/1/SA/AT/WH	AXN 3.0 con Ottica Universale 2W LED 380 lm PREMIUM IP20 1h autonomia, SE + SA, con AUTOTEST, colore Bianco	103,45 €
	AX3N/U/2W/B/3/SA/AT/WH	AXN 3.0 con Ottica Universale 2W LED 310 lm PREMIUM IP20 3h autonomia, SE + SA, con AUTOTEST, colore Bianco	115,79 €
	AX3N/R/1W/B/1/SE/AT/WH	AXN 3.0 Ottica per vie di Fuga 1W LED 250 lm PREMIUM IP20 1h autonomia, SE, con AUTOTEST, colore Bianco	86,46 €
	AX3N/R/1W/B/3/SE/AT/WH	AXN 3.0 Ottica per vie di Fuga 1W LED 200 lm PREMIUM IP20 3h autonomia, SE, con AUTOTEST, colore Bianco	92,65 €
	AX3N/R/2W/B/1/SE/AT/WH	AXN 3.0 Ottica per vie di Fuga 2W LED 380 lm PREMIUM IP20 1h autonomia, SE, con AUTOTEST, colore Bianco	95,73 €
	AX3N/R/2W/B/3/SE/AT/WH	AXN 3.0 Ottica per vie di Fuga 2W LED 310 lm PREMIUM IP20 3h autonomia, SE, con AUTOTEST, colore Bianco	108,07 €
	AX3N/R/1W/B/1/SA/AT/WH	AXN 3.0 Ottica per vie di Fuga 1W LED 250 lm PREMIUM IP20 1h autonomia, SE + SA, con AUTOTEST, colore Bianco	94,18 €
	AX3N/R/1W/B/3/SA/AT/WH	AXN 3.0 Ottica per vie di Fuga 1W LED 200 lm PREMIUM IP20 3h autonomia, SE + SA, con AUTOTEST, colore Bianco	100,37 €
	AX3N/R/2W/B/1/SA/AT/WH	AXN 3.0 Ottica per vie di Fuga 2W LED 380 lm PREMIUM IP20 1h autonomia, SE + SA, con AUTOTEST, colore Bianco	103,45 €
	AX3N/R/2W/B/3/SA/AT/WH	AXN 3.0 Ottica per vie di Fuga 2W LED 310 lm PREMIUM IP20 3h autonomia, SE + SA, con AUTOTEST, colore Bianco	115,79 €
	AX3N/O/1W/B/1/SE/AT/WH	AXN 3.0 Ottica open area 1W LED 250 lm PREMIUM IP20 1h autonomia, SE, con AUTOTEST, colore Bianco	86,46 €
	AX3N/O/1W/B/3/SE/AT/WH	AXN 3.0 Ottica open area 1W LED 200 lm PREMIUM IP20 3h autonomia, SE, con AUTOTEST, colore Bianco	92,65 €
	AX3N/O/2W/B/1/SE/AT/WH	AXN 3.0 Ottica open area 2W LED 380 lm PREMIUM IP20 1h autonomia, SE, con AUTOTEST, colore Bianco	95,73 €
	AX3N/O/2W/B/3/SE/AT/WH	AXN 3.0 Ottica open area 2W LED 310 lm PREMIUM IP20 3h autonomia, SE, con AUTOTEST, colore Bianco	108,07 €
	AX3N/O/1W/B/1/SA/AT/WH	AXN 3.0 Ottica open area 1W LED 250 lm PREMIUM IP20 1h autonomia, SE + SA, con AUTOTEST, colore Bianco	94,18 €
	AX3N/O/1W/B/3/SA/AT/WH	AXN 3.0 Ottica open area 1W LED 200 lm PREMIUM IP20 3h autonomia, SE + SA, con AUTOTEST, colore Bianco	100,37 €
	AX3N/O/2W/B/1/SA/AT/WH	AXN 3.0 Ottica open area 2W LED 380 lm PREMIUM IP20 1h autonomia, SE + SA, con AUTOTEST, colore Bianco	103,45 €
	AX3N/O/2W/B/3/SA/AT/WH	AXN 3.0 Ottica open area 2W LED 310 lm PREMIUM IP20 3h autonomia, SE + SA, con AUTOTEST, colore Bianco	115,79 €

LEGGENDA:

SE	Emergenza	E	Apparecchio autonomo con elettronica tipo STANDARD
SA	Emergenza + SA	C	Apparecchio autonomo con elettronica tipo STANDARD
AT	autotest	B	Apparecchio autonomo con elettronica tipo PREMIUM
CB	central battery	F	Apparecchio NON AUTONOMO - Alimentazione centralizzata

AXP 3



AC
220-240V
50-60Hz

DC
176-275V

DC
24V

DC
48V

LED

IP20

IK07



MATERIALI

Corpo Bianco, Grigio o Nero in policarbonato

MONTAGGIO

Incasso

ALIMENTAZIONE

Autonoma – 220 - 240VAC/50 - 60Hz
Central battery – 220 - 240VAC/50 - 60Hz; 176 - 275VDC
Central battery FZLV II – 48VDC *
Central battery FZLV – 24VDC *

SORGENTE LUMINOSA

1W, 2W, LED
Ottica: A – wall • O – open area • U – universale • R – vie di fuga
• R1 – vie di fuga • R2 – vie di fuga

RICARICA

Premium: max. 12h; charger a risparmio energetico

AUTONOMIA E BATTERIE

Premium: 1h o 3h, LiFePO₄ 3,2V batteria

CLASSE

II o III

GRADO IP & IK

IP20, IK07

TEMPERATURA

Autonoma: t_a: 0°C ÷ 40°C **Central battery:** t_a: 0°C ÷ 50°C

OPZIONI

SE – Solo emergenza • SA – sempre accesa • AT – autotest • PT – pulsante di test
• CB – central battery • Versioni central test RUBIC o alimentazione e controllo centralizzato *

INFORMAZIONI

* su richiesta

DIMENSIONI [mm]

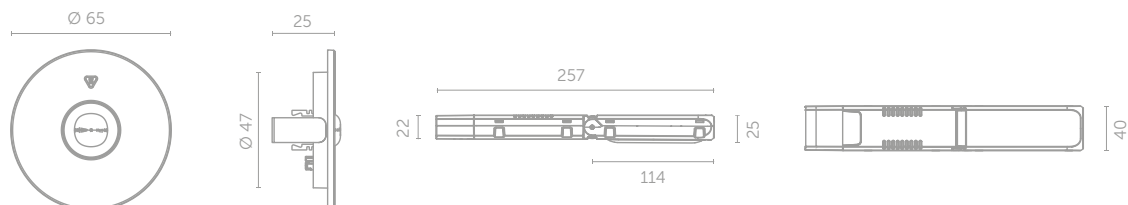

	CODICE ORDINE	LED SPOT AXP 3	LISTINO
		IP20	
PREMIUM	AX3P/A/1W/B/1/SE/X/WH	AXP 3.0 Ottica Wall 1W LED 250 lm PREMIUM IP20 1h autonomia, SE, colore Bianco	71,02 €
	AX3P/A/1W/B/3/SE/X/WH	AXP 3.0 Ottica Wall 1W LED 200 lm PREMIUM IP20 3h autonomia, SE, colore Bianco	77,21 €
	AX3P/A/2W/B/1/SE/X/WH	AXP 3.0 Ottica Wall 2W LED 380 lm PREMIUM IP20 1h autonomia, SE, colore Bianco	80,29 €
	AX3P/A/2W/B/3/SE/X/WH	AXP 3.0 Ottica Wall 2W LED 310 lm PREMIUM IP20 3h autonomia, SE, colore Bianco	92,65 €
	AX3P/A/1W/B/1/SA/X/WH	AXP 3.0 Ottica Wall 1W LED 250 lm PREMIUM IP20 1h autonomia, SE + SA, colore Bianco	78,74 €
	AX3P/A/1W/B/3/SA/X/WH	AXP 3.0 Ottica Wall 1W LED 200 lm PREMIUM IP20 3h autonomia, SE + SA, colore Bianco	84,93 €
	AX3P/A/2W/B/1/SA/X/WH	AXP 3.0 Ottica Wall 2W LED 380 lm PREMIUM IP20 1h autonomia, SE + SA, colore Bianco	88,01 €
	AX3P/A/2W/B/3/SA/X/WH	AXP 3.0 Ottica Wall 2W LED 310 lm PREMIUM IP20 3h autonomia, SE + SA, colore Bianco	100,37 €
	AX3P/O/1W/B/1/SE/X/WH	AXP 3.0 Ottica open area 1W LED 250 lm PREMIUM IP20 1h autonomia, SE, colore Bianco	71,02 €
	AX3P/O/1W/B/3/SE/X/WH	AXP 3.0 Ottica open area 1W LED 200 lm PREMIUM IP20 3h autonomia, SE, colore Bianco	77,21 €
	AX3P/O/2W/B/1/SE/X/WH	AXP 3.0 Ottica open area 2W LED 380 lm PREMIUM IP20 1h autonomia, SE, colore Bianco	80,29 €
	AX3P/O/2W/B/3/SE/X/WH	AXP 3.0 Ottica open area 2W LED 310 lm PREMIUM IP20 3h autonomia, SE, colore Bianco	92,65 €
	AX3P/O/1W/B/1/SA/X/WH	AXP 3.0 Ottica open area 1W LED 250 lm PREMIUM IP20 1h autonomia, SE + SA, colore Bianco	78,74 €
	AX3P/O/1W/B/3/SA/X/WH	AXP 3.0 Ottica open area 1W LED 200 lm PREMIUM IP20 3h autonomia, SE + SA, colore Bianco	84,93 €
	AX3P/O/2W/B/1/SA/X/WH	AXP 3.0 Ottica open area 2W LED 380 lm PREMIUM IP20 1h autonomia, SE + SA, colore Bianco	88,01 €
	AX3P/O/2W/B/3/SA/X/WH	AXP 3.0 Ottica open area 2W LED 310 lm PREMIUM IP20 3h autonomia, SE + SA, colore Bianco	100,37 €
	AX3P/U/1W/B/1/SE/X/WH	AXP 3.0 con Ottica Universale 1W LED 250 lm PREMIUM IP20 1h autonomia, SE, colore Bianco	71,02 €
	AX3P/U/1W/B/3/SE/X/WH	AXP 3.0 con Ottica Universale 1W LED 200 lm PREMIUM IP20 3h autonomia, SE, colore Bianco	77,21 €
	AX3P/U/2W/B/1/SE/X/WH	AXP 3.0 con Ottica Universale 2W LED 380 lm PREMIUM IP20 1h autonomia, SE, colore Bianco	80,29 €
	AX3P/U/2W/B/3/SE/X/WH	AXP 3.0 con Ottica Universale 2W LED 310 lm PREMIUM IP20 3h autonomia, SE, colore Bianco	92,65 €
	AX3P/U/1W/B/1/SA/X/WH	AXP 3.0 con Ottica Universale 1W LED 250 lm PREMIUM IP20 1h autonomia, SE + SA, colore Bianco	78,74 €
	AX3P/U/1W/B/3/SA/X/WH	AXP 3.0 con Ottica Universale 1W LED 200 lm PREMIUM IP20 3h autonomia, SE + SA, colore Bianco	84,93 €
	AX3P/U/2W/B/1/SA/X/WH	AXP 3.0 con Ottica Universale 2W LED 380 lm PREMIUM IP20 1h autonomia, SE + SA, colore Bianco	88,01 €
	AX3P/U/2W/B/3/SA/X/WH	AXP 3.0 con Ottica Universale 2W LED 310 lm PREMIUM IP20 3h autonomia, SE + SA, colore Bianco	100,37 €
	AX3P/R/1W/B/1/SE/X/WH	AXP 3.0 Ottica per vie di Fuga 1W LED 250 lm PREMIUM IP20 1h autonomia, SE, colore Bianco	71,02 €
	AX3P/R/1W/B/3/SE/X/WH	AXP 3.0 Ottica per vie di Fuga 1W LED 200 lm PREMIUM IP20 3h autonomia, SE, colore Bianco	77,21 €
	AX3P/R/2W/B/1/SE/X/WH	AXP 3.0 Ottica per vie di Fuga 2W LED 380 lm PREMIUM IP20 1h autonomia, SE, colore Bianco	80,29 €
	AX3P/R/2W/B/3/SE/X/WH	AXP 3.0 Ottica per vie di Fuga 2W LED 310 lm PREMIUM IP20 3h autonomia, SE, colore Bianco	92,65 €
	AX3P/R/1W/B/1/SA/X/WH	AXP 3.0 Ottica per vie di Fuga 1W LED 250 lm PREMIUM IP20 1h autonomia, SE + SA, colore Bianco	78,74 €
	AX3P/R/1W/B/3/SA/X/WH	AXP 3.0 Ottica per vie di Fuga 1W LED 200 lm PREMIUM IP20 3h autonomia, SE + SA, colore Bianco	84,93 €
AX3P/R/2W/B/1/SA/X/WH	AXP 3.0 Ottica per vie di Fuga 2W LED 380 lm PREMIUM IP20 1h autonomia, SE + SA, colore Bianco	88,01 €	
AX3P/R/2W/B/3/SA/X/WH	AXP 3.0 Ottica per vie di Fuga 2W LED 310 lm PREMIUM IP20 3h autonomia, SE + SA, colore Bianco	100,37 €	

	CODICE ORDINE	LED SPOT AXP 3	LISTINO
		IP20	
PREMIUM CON AUTOTEST	AX3P/A/1W/B/1/SE/AT/WH	AXP 3.0 Ottica Wall 1W LED 250 lm PREMIUM IP20 1h autonomia, SE, con AUTOTEST, colore Bianco	86,46 €
	AX3P/A/1W/B/3/SE/AT/WH	AXP 3.0 Ottica Wall 1W LED 200 lm PREMIUM IP20 3h autonomia, SE, con AUTOTEST, colore Bianco	92,65 €
	AX3P/A/2W/B/1/SE/AT/WH	AXP 3.0 Ottica Wall 2W LED 380 lm PREMIUM IP20 1h autonomia, SE, con AUTOTEST, colore Bianco	95,73 €
	AX3P/A/2W/B/3/SE/AT/WH	AXP 3.0 Ottica Wall 2W LED 310 lm PREMIUM IP20 3h autonomia, SE, con AUTOTEST, colore Bianco	108,07 €
	AX3P/A/1W/B/1/SA/AT/WH	AXP 3.0 Ottica Wall 1W LED 250 lm PREMIUM IP20 1h autonomia, SE + SA, con AUTOTEST, colore Bianco	94,18 €
	AX3P/A/1W/B/3/SA/AT/WH	AXP 3.0 Ottica Wall 1W LED 200 lm PREMIUM IP20 3h autonomia, SE + SA, con AUTOTEST, colore Bianco	100,37 €
	AX3P/A/2W/B/1/SA/AT/WH	AXP 3.0 Ottica Wall 2W LED 380 lm PREMIUM IP20 1h autonomia, SE + SA, con AUTOTEST, colore Bianco	103,45 €
	AX3P/A/2W/B/3/SA/AT/WH	AXP 3.0 Ottica Wall 2W LED 310 lm PREMIUM IP20 3h autonomia, SE + SA, con AUTOTEST, colore Bianco	115,79 €
	AX3P/O/1W/B/1/SE/AT/WH	AXP 3.0 Ottica open area 1W LED 250 lm PREMIUM IP20 1h autonomia, SE, con AUTOTEST, colore Bianco	86,46 €
	AX3P/O/1W/B/3/SE/AT/WH	AXP 3.0 Ottica open area 1W LED 200 lm PREMIUM IP20 3h autonomia, SE, con AUTOTEST, colore Bianco	92,65 €
	AX3P/O/2W/B/1/SE/AT/WH	AXP 3.0 Ottica open area 2W LED 380 lm PREMIUM IP20 1h autonomia, SE, con AUTOTEST, colore Bianco	95,73 €
	AX3P/O/2W/B/3/SE/AT/WH	AXP 3.0 Ottica open area 2W LED 310 lm PREMIUM IP20 3h autonomia, SE, con AUTOTEST, colore Bianco	108,07 €
	AX3P/O/1W/B/1/SA/AT/WH	AXP 3.0 Ottica open area 1W LED 250 lm PREMIUM IP20 1h autonomia, SE + SA, con AUTOTEST, colore Bianco	94,18 €
	AX3P/O/1W/B/3/SA/AT/WH	AXP 3.0 Ottica open area 1W LED 200 lm PREMIUM IP20 3h autonomia, SE + SA, con AUTOTEST, colore Bianco	100,37 €
	AX3P/O/2W/B/1/SA/AT/WH	AXP 3.0 Ottica open area 2W LED 380 lm PREMIUM IP20 1h autonomia, SE + SA, con AUTOTEST, colore Bianco	103,45 €
	AX3P/O/2W/B/3/SA/AT/WH	AXP 3.0 Ottica open area 2W LED 310 lm PREMIUM IP20 3h autonomia, SE + SA, con AUTOTEST, colore Bianco	115,79 €
	AX3P/U/1W/B/1/SE/AT/WH	AXP 3.0 con Ottica Universale 1W LED 250 lm PREMIUM IP20 1h autonomia, SE, con AUTOTEST, colore Bianco	86,46 €
	AX3P/U/1W/B/3/SE/AT/WH	AXP 3.0 con Ottica Universale 1W LED 200 lm PREMIUM IP20 3h autonomia, SE, con AUTOTEST, colore Bianco	92,65 €
	AX3P/U/2W/B/1/SE/AT/WH	AXP 3.0 con Ottica Universale 2W LED 380 lm PREMIUM IP20 1h autonomia, SE, con AUTOTEST, colore Bianco	95,73 €
	AX3P/U/2W/B/3/SE/AT/WH	AXP 3.0 con Ottica Universale 2W LED 310 lm PREMIUM IP20 3h autonomia, SE, con AUTOTEST, colore Bianco	108,07 €
	AX3P/U/1W/B/1/SA/AT/WH	AXP 3.0 con Ottica Universale 1W LED 250 lm PREMIUM IP20 1h autonomia, SE + SA, con AUTOTEST, colore Bianco	94,18 €
	AX3P/U/1W/B/3/SA/AT/WH	AXP 3.0 con Ottica Universale 1W LED 200 lm PREMIUM IP20 3h autonomia, SE + SA, con AUTOTEST, colore Bianco	100,37 €
	AX3P/U/2W/B/1/SA/AT/WH	AXP 3.0 con Ottica Universale 2W LED 380 lm PREMIUM IP20 1h autonomia, SE + SA, con AUTOTEST, colore Bianco	103,45 €
	AX3P/U/2W/B/3/SA/AT/WH	AXP 3.0 con Ottica Universale 2W LED 310 lm PREMIUM IP20 3h autonomia, SE + SA, con AUTOTEST, colore Bianco	115,79 €
	AX3P/R/1W/B/1/SE/AT/WH	AXP 3.0 Ottica per vie di Fuga 1W LED 250 lm PREMIUM IP20 1h autonomia, SE, con AUTOTEST, colore Bianco	86,46 €
	AX3P/R/1W/B/3/SE/AT/WH	AXP 3.0 Ottica per vie di Fuga 1W LED 200 lm PREMIUM IP20 3h autonomia, SE, con AUTOTEST, colore Bianco	92,65 €
	AX3P/R/2W/B/1/SE/AT/WH	AXP 3.0 Ottica per vie di Fuga 2W LED 380 lm PREMIUM IP20 1h autonomia, SE, con AUTOTEST, colore Bianco	95,73 €
	AX3P/R/2W/B/3/SE/AT/WH	AXP 3.0 Ottica per vie di Fuga 2W LED 310 lm PREMIUM IP20 3h autonomia, SE, con AUTOTEST, colore Bianco	108,07 €
	AX3P/R/1W/B/1/SA/AT/WH	AXP 3.0 Ottica per vie di Fuga 1W LED 250 lm PREMIUM IP20 1h autonomia, SE + SA, con AUTOTEST, colore Bianco	94,18 €
	AX3P/R/1W/B/3/SA/AT/WH	AXP 3.0 Ottica per vie di Fuga 1W LED 200 lm PREMIUM IP20 3h autonomia, SE + SA, con AUTOTEST, colore Bianco	100,37 €
AX3P/R/2W/B/1/SA/AT/WH	AXP 3.0 Ottica per vie di Fuga 2W LED 380 lm PREMIUM IP20 1h autonomia, SE + SA, con AUTOTEST, colore Bianco	103,45 €	
AX3P/R/2W/B/3/SA/AT/WH	AXP 3.0 Ottica per vie di Fuga 2W LED 310 lm PREMIUM IP20 3h autonomia, SE + SA, con AUTOTEST, colore Bianco	115,79 €	

LEGGENDA:

SE	Emergenza	E	Apparecchio autonomo con elettronica tipo STANDARD
SA	Emergenza + SA	C	Apparecchio autonomo con elettronica tipo STANDARD
AT	autotest	B	Apparecchio autonomo con elettronica tipo PREMIUM
CB	central battery	F	Apparecchio NON AUTONOMO - Alimentazione centralizzata

AX 3 accessori



**ACCESSORIO PER INCASSO NEL
CONTROSOFFITTO**

CODICE: AX3N/REC/WH
AX3N/REC/GR
AX3N/REC/BL

DIMENSIONI [mm]

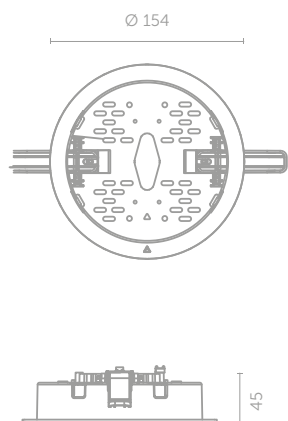

ADATTABILE A AXN 3



**SCATOLA PER MONTAGGIO IN
SUPERFICIE CON INGRESSO
CAVI LATERALE**

CODICE: AX3N/BOX/WH
AX3N/BOX/GR
AX3N/BOX/BL

DIMENSIONI [mm]

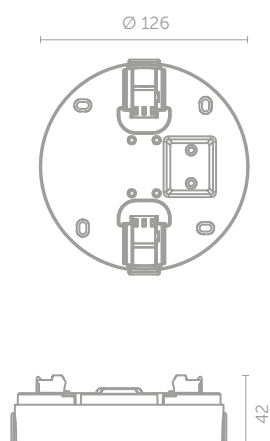

ADATTABILE A AXN 3



LOVATO II

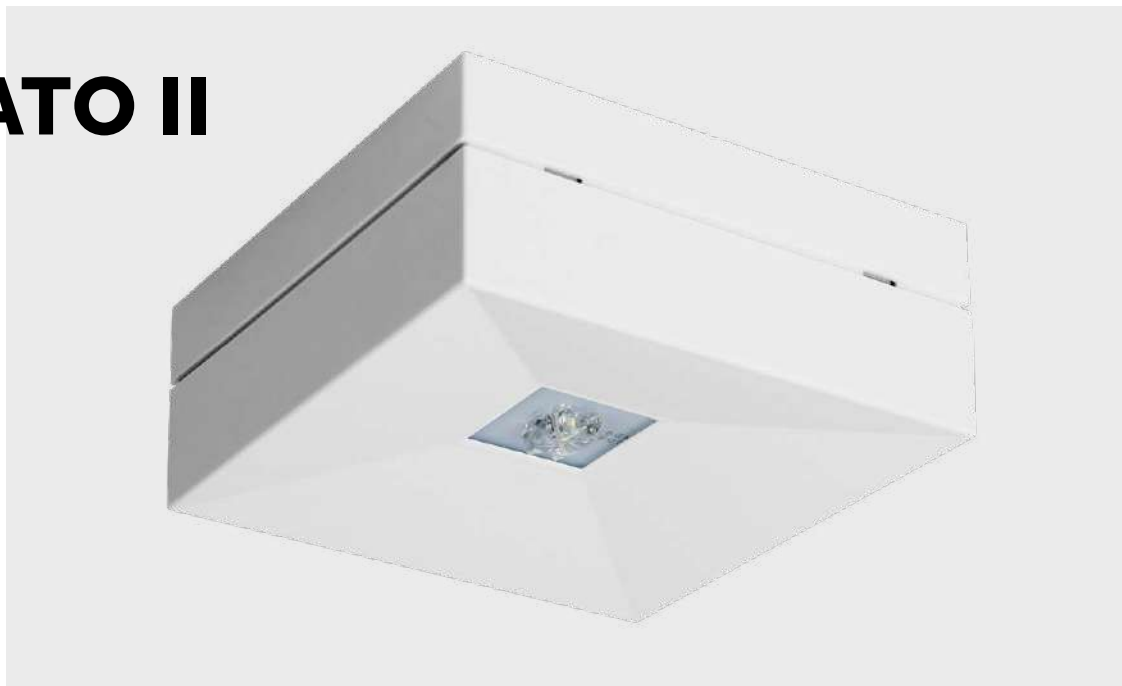

AC
220-240V
50-60Hz

DC
176-275V

DC
24V

DC
48V

LED

IP41

IK07

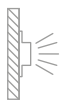

KM 618355
BS-EN 60598-2-22



MATERIALI	Corpo Bianco, Grigio o Nero in policarbonato
MONTAGGIO	Superficie
ALIMENTAZIONE	Autonoma – 220 - 240VAC/50 - 60Hz Central battery – 220 - 240VAC/50 - 60Hz; 176 - 275VDC Central battery FZLV II – 48VDC * Central battery FZLV – 24VDC *
SORGENTE LUMINOSA	1W, 2W, 3W, 4W LED Ottica: A – wall • O – open area • U – universale • R – vie di fuga • C – corridoio
RICARICA	Standard: max. 24h Premium: max. 12h; charger a risparmio energetico
AUTONOMIA E BATTERIE	Standard: 1h o 3h, Ni-Cd 3,6V batteria Premium: 1h o 3h, LiFePO ₄ 6,4V batteria
CLASSE	II o III
GRADO IP & IK	IP41, IK07
TEMPERATURA	Autonoma: t _a : 0°C ÷ 40°C Central battery: t _a : 0°C ÷ 50°C
OPZIONI	SE – Solo emergenza • SA – sempre accesa • AT – autotest • PT – pulsante di test • CB – central battery • Versioni central test RUBIC o alimentazione e controllo centralizzato *
INFORMAZIONI	LED indicazione stato alimentazione e ricarica batteria • Protezione contro scarica profonda • Classe di isolamento III per versione FZLV e FZLV2

* su richiesta

DIMENSIONI [mm]

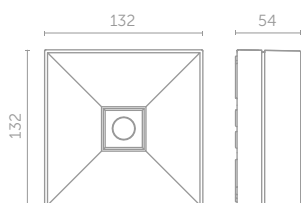

	CODICE ORDINE	LOVATO II	LISTINO
		IP41	
CENTRAL BATTERY	LV2O/3W/F/CB/X/WH	LOVATO II Ottica open area 3W LED 460 lm IP41 per central battery system, colore Bianco	62,82 €
	LV2U/3W/F/CB/X/WH	LOVATO II con Ottica Universale 3W LED 460 lm IP41 per central battery system, colore Bianco	69,22 €
	LV2C/3W/F/CB/X/WH	LOVATO II Ottica per corridoi 3W LED 460 lm IP41 per central battery system, colore Bianco	71,35 €
	LV2R/3W/F/CB/X/WH	LOVATO II Ottica per vie di fuga 3W LED 460 lm IP41 per central battery system, colore Bianco	121,04 €
	LV2O/4W/F/CB/X/WH	LOVATO II Ottica open area 4W LED 550 lm IP41 per central battery system, colore Bianco	121,04 €
	LV2U/4W/F/CB/X/WH	LOVATO II con Ottica Universale 4W LED 550 lm IP41 per central battery system, colore Bianco	121,04 €
	LV2C/4W/F/CB/X/WH	LOVATO II Ottica per corridoi 4W LED 550 lm IP41 per central battery system, colore Bianco	121,04 €
	LV2R/4W/F/CB/X/WH	LOVATO II Ottica per vie di fuga 4W LED 550 lm IP41 per central battery system, colore Bianco	121,04 €

LEGGENDA:

SE	Emergenza	E	Apparecchio autonomo con elettronica tipo STANDARD
SA	Emergenza + SA	C	Apparecchio autonomo con elettronica tipo STANDARD
AT	autotest	B	Apparecchio autonomo con elettronica tipo PREMIUM
CB	central battery	F	Apparecchio NON AUTONOMO - Alimentazione centralizzata

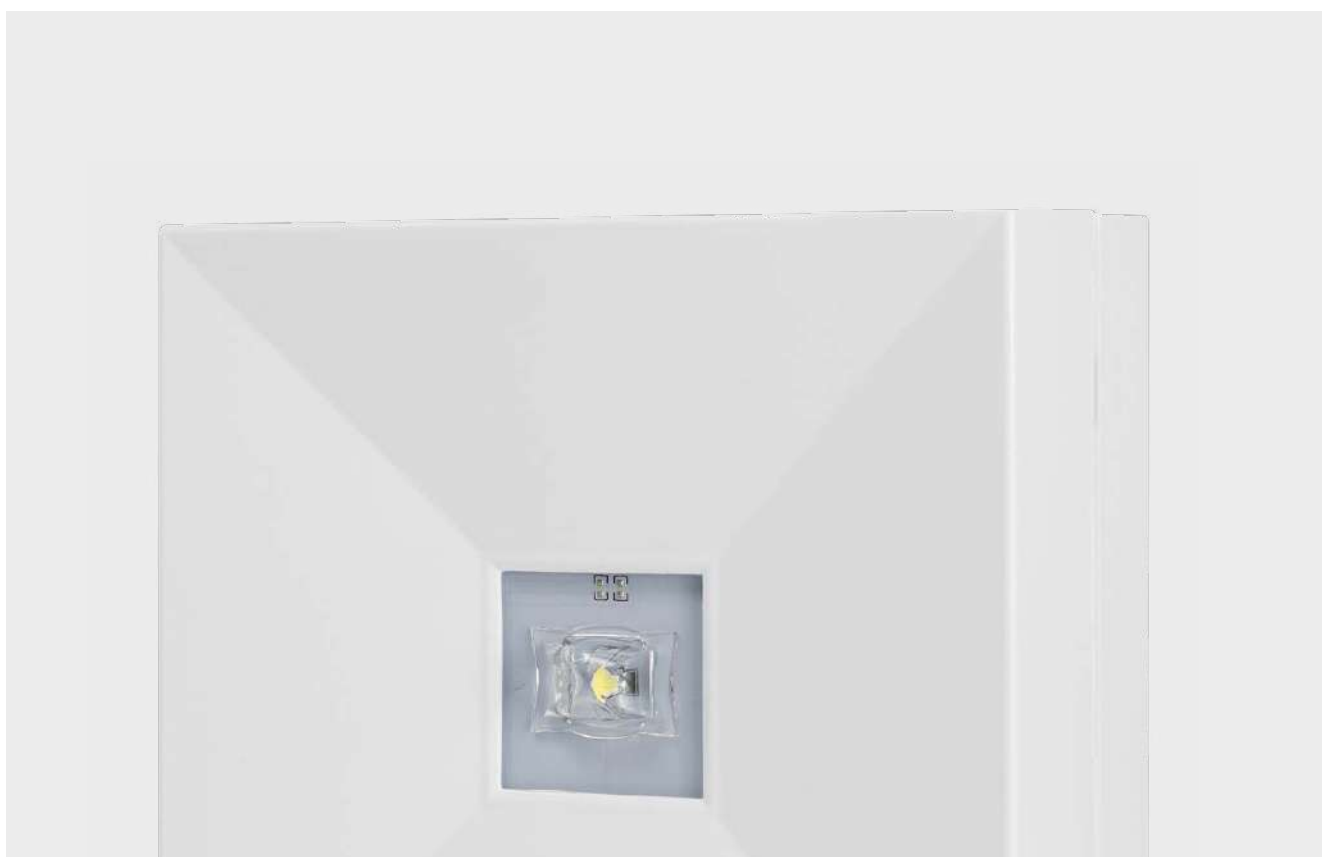

LOVATO P



AC
220-240V
50-60Hz

DC
176-275V

DC
24V

DC
48V

LED

IP20

IK08



KM 618355
BS-EN 60598-2-22



MATERIALI

Corpo Bianco, Grigio o Nero in policarbonato

MONTAGGIO

Incasso

ALIMENTAZIONE

Autonoma – 220 - 240VAC/50 - 60Hz
Central battery – 220 - 240VAC/50 - 60Hz; 176 - 275VDC
Central battery FZLV II – 48VDC *
Central battery FZLV – 24VDC *

SORGENTE LUMINOSA

1W, 2W, 3W, 4W, 6W LED

Ottica: A – wall • O – open area • U – universale • R – vie di fuga • C - corridoio

RICARICA

Standard: max. 24h

Premium: max. 12h; charger a risparmio energetico

AUTONOMIA E BATTERIE

Standard: 1h o 3h, Ni-Cd 3,6V batteria

Premium: 1h o 3h, LiFePO₄ 6,4V batteria

CLASSE

II o III

GRADO IP & IK

IP20, IK08

TEMPERATURA

Autonoma: t_g: 0°C ÷ 40°C **Central battery:** t_g: 0°C ÷ 50°C

OPZIONI

SE – Solo emergenza • SA – sempre accesa • AT – autotest • CB – central battery • Versioni central test RUBIC o alimentazione e controllo centralizzato *

INFORMAZIONI

LED indicazione stato alimentazione e ricarica batteria • Protezione contro scarica profonda • Classe di isolamento III per versione FZLV e FZLV2

* su richiesta

DIMENSIONI [mm]

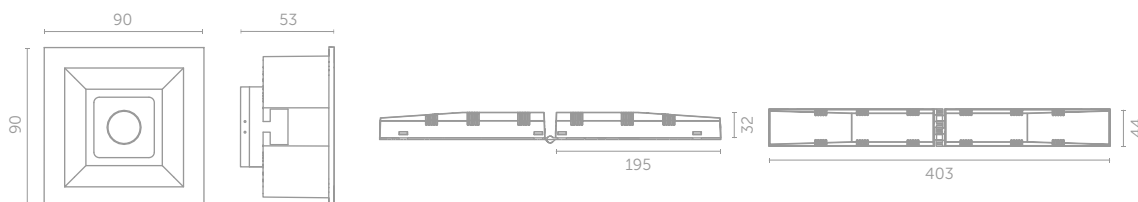

	CODICE ORDINE	LOVATO P	LISTINO
		IP20	
CENTRAL BATTERY	LVPO/3W/F/CB/X/WH	LOVATO P Ottica open area 3W LED 460 lm IP20 per central battery system, colore Bianco	114,14 €
	LVPU/3W/F/CB/X/WH	LOVATO P con Ottica Universale 3W LED 410 lm IP20 per central battery system, colore Bianco	114,14 €
	LVPC/3W/F/CB/X/WH	LOVATO P Ottica per corridoi 3W LED 385 lm IP20 per central battery system, colore Bianco	114,14 €
	LVPR/3W/F/CB/X/WH	LOVATO P Ottica per vie di fuga 3W LED 460 lm IP20 per central battery system, colore Bianco	114,14 €
	LVPO/4W/F/CB/X/WH	LOVATO P Ottica open area 4W LED 550 lm IP20 per central battery system, colore Bianco	121,04 €
	LVPU/4W/F/CB/X/WH	LOVATO P con Ottica Universale 4W LED 550 lm IP20 per central battery system, colore Bianco	121,04 €
	LVPC/4W/F/CB/X/WH	LOVATO P Ottica per corridoi 4W LED 550 lm IP20 per central battery system, colore Bianco	121,04 €
	LVPR/4W/F/CB/X/WH	LOVATO P Ottica per vie di fuga 4W LED 550 lm IP20 per central battery system, colore Bianco	121,04 €
	LVPO/6W/F/CB/X/WH	LOVATO P Ottica open area 4W LED 785 lm IP20 per central battery system, colore Bianco	155,11 €
	LVPU/6W/F/CB/X/WH	LOVATO P con Ottica Universale 4W LED 785 lm IP20 per central battery system, colore Bianco	155,11 €
	LVPC/6W/F/CB/X/WH	LOVATO P Ottica per corridoi 4W LED 785 lm IP20 per central battery system, colore Bianco	155,11 €
	LVPR/6W/F/CB/X/WH	LOVATO P Ottica per vie di fuga 4W LED 785 lm IP20 per central battery system, colore Bianco	155,11 €

LEGGENDA:

SE	Emergenza	E	Apparecchio autonomo con elettronica tipo STANDARD
SA	Emergenza + SA	C	Apparecchio autonomo con elettronica tipo STANDARD
AT	autotest	B	Apparecchio autonomo con elettronica tipo PREMIUM
CB	central battery	F	Apparecchio NON AUTONOMO - Alimentazione centralizzata



LOVATO accessori



SCATOLA PER MONTAGGIO IN SUPERFICIE CON INGRESSO CAVI LATERALE

CODICE: LV2/BOX/WH
LV2/BOX/GR
LV2/BOX/BL

DIMENSIONI [mm]

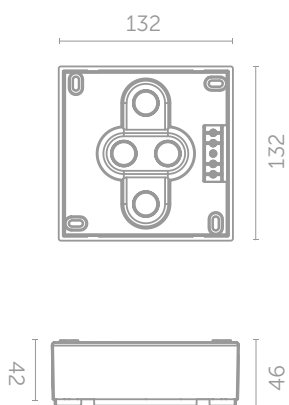

ADATTABILE A LOVATO II

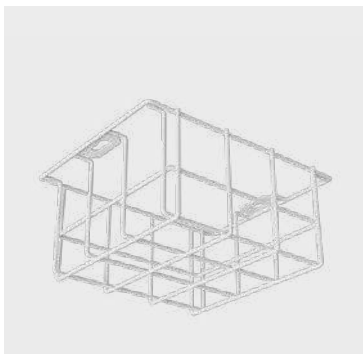

GRIGLIA DI PROTEZIONE

CODICE: 1015

DIMENSIONI [mm]

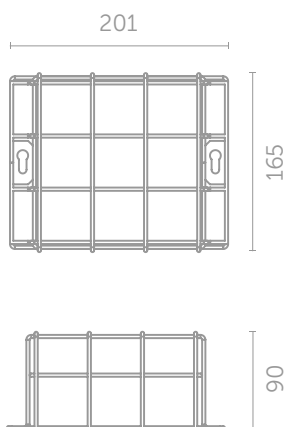

ADATTABILE A LOVATO II



AXN



AC
220-240V
50-60Hz

DC
176-275V

DC
24V

DC
48V

LED

IP65

IK08

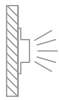

KIM 618355
BS-EN 60598-2-22



MATERIALI	Corpo Bianco, Grigio o Nero in policarbonato
MONTAGGIO	Superficie
ALIMENTAZIONE	Autonoma – 220 - 240VAC/50 - 60Hz Central battery – 220 - 240VAC/50 - 60Hz; 176 - 275VDC Central battery FZLV II – 48VDC * Central battery FZLV – 24VDC *
SORGENTE LUMINOSA	1W, 2W, 3W, 4W, 6W LED Ottica: A – wall • O – open area • U – universale • R – vie di fuga • C - corridoio
RICARICA	Standard: max. 24h Premium: max. 12h; charger a risparmio energetico
AUTONOMIA E BATTERIE	Standard: 1h o 3h, Ni-Cd 3,6V batteria Premium: 1h o 3h, LiFePO ₄ 6,4V batteria
CLASSE	II o III
GRADO IP & IK	IP65, IK08
TEMPERATURA	Autonoma: t _a : 0°C ÷ 40°C • Central battery: t _a : -25°C ÷ 50°C
OPZIONI	SE – Solo emergenza • SA – sempre accesa • AT – autotest • PT – pulsante di test • CB – central battery • Versioni central test RUBIC o alimentazione e controllo centralizzato *
INFORMAZIONI	LED indicazione stato alimentazione e ricarica batteria • Protezione contro scarica profonda • Classe di isolamento III per versione FZLV e FZLV2

* su richiesta

DIMENSIONI [mm]

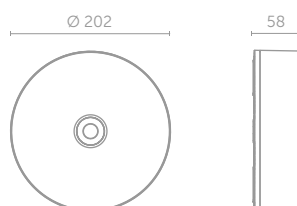

	CODICE ORDINE	AXN	LISTINO
		IP65	
CENTRAL BATTERY	AXNO/3W/F/CB/X/WH	AXN Ottica open area 3W LED 460 lm IP65 for central battery colore Bianco	125,05 €
	AXNO/4W/F/CB/X/WH	AXN Ottica open area 4W LED 550 lm IP65 for central battery colore Bianco	147,98 €
	AXNO/6W/F/CB/X/WH	AXN Ottica open area 6W LED 780 lm IP65 for central battery colore Bianco	155,11 €
	AXNU/3W/F/CB/X/WH	AXN con Ottica Universale 3W LED 460 lm IP65 for central battery colore Bianco	125,05 €
	AXNU/4W/F/CB/X/WH	AXN con Ottica Universale 4W LED 550 lm IP65 for central battery colore Bianco	147,98 €
	AXNU/6W/F/CB/X/WH	AXN con Ottica Universale 6W LED 805 lm IP65 for central battery colore Bianco	155,11 €
	AXNC/3W/F/CB/X/WH	AXN Ottica per corridoi 3W LED 460 lm IP65 for central battery colore Bianco	125,05 €
	AXNC/4W/F/CB/X/WH	AXN Ottica per corridoi 4W LED 550 lm IP65 for central battery colore Bianco	147,98 €
	AXNC/6W/F/CB/X/WH	AXN Ottica per corridoi 6W LED 790 lm IP65 for central battery colore Bianco	155,11 €
	AXNR/3W/F/CB/X/WH	AXN Ottica per vie di Fuga 3W LED 460 lm IP65 for central battery colore Bianco	125,05 €
	AXNR/4W/F/CB/X/WH	AXN Ottica per vie di Fuga 4W LED 550 lm IP65 for central battery colore Bianco	147,98 €
	AXNR/6W/F/CB/X/WH	AXN Ottica per vie di Fuga 6W LED 790 lm IP65 for central battery colore Bianco	155,11 €

LEGGENDA:

SE	Emergenza	E	Apparecchio autonomo con elettronica tipo STANDARD
SA	Emergenza + SA	C	Apparecchio autonomo con elettronica tipo STANDARD
AT	autotest	B	Apparecchio autonomo con elettronica tipo PREMIUM
CB	central battery	F	Apparecchio NON AUTONOMO - Alimentazione centralizzata



AXP



AC
220-240V
50-60Hz

DC
176-275V

DC
24V

DC
48V

LED

IP20

IK08



KM 618355
BS-EN 60598-2-22



MATERIALI

Corpo Bianco, Grigio o Nero in policarbonato

MONTAGGIO

Incasso

ALIMENTAZIONE

Autonoma – 220 - 240VAC/50 - 60Hz
Central battery – 220 - 240VAC/50 - 60Hz; 176 - 275VDC
Central battery FZLV II – 48VDC *
Central battery FZLV – 24VDC *

SORGENTE LUMINOSA

1W, 2W, 3W, 4W, 6W LED

Ottica: A – wall • O – open area • U – universale • R – vie di fuga • C – corridoio

RICARICA

Standard: max. 24h

Premium: max. 12h; charger a risparmio energetico

AUTONOMIA E BATTERIE

Standard: 1h o 3h, Ni-Cd 3,6V batteria

Premium: 1h o 3h, LiFePO₄ 6,4V batteria

CLASSE

II o III

GRADO IP & IK

IP20, IK08

TEMPERATURA

Autonoma: t_a: 0°C ÷ 40°C **Central battery:** t_a: 0°C ÷ 50°C

OPZIONI

SE – Solo emergenza • SA – sempre accesa • AT – autotest • CB – central battery
• Versioni central test RUBIC o alimentazione e controllo centralizzato *

INFORMAZIONI

LED indicazione stato alimentazione e ricarica batteria • Protezione contro scarica profonda
• Classe di isolamento III per versione FZLV e FZLV2

* su richiesta

DIMENSIONI [mm]

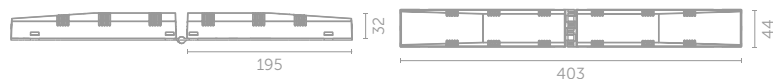
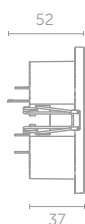
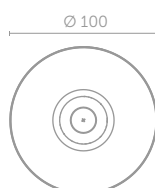

403

	CODICE ORDINE	AXP	LISTINO
		IP20	
CENTRAL BATTERY	AXEPO/3W/F/CBS/WH	AXP Ottica open area 3W LED 460 lm IP65 for central battery colore Bianco	125,05 €
	AXEPO/4W/F/CBS/WH	AXP Ottica open area 4W LED 550 lm IP65 for central battery colore Bianco	127,36 €
	AXEPO/6W/F/CBS/WH	AXP Ottica open area 6W LED 775 lm IP65 for central battery colore Bianco	144,19 €
	AXEPU/3W/F/CBS/WH	AXP Ottica Universale 3W LED 460 lm IP65 for central battery colore Bianco	125,05 €
	AXEPU/4W/F/CBS/WH	AXP OtticaUniversale 4W LED 550 lm IP65 for central battery colore Bianco	127,36 €
	AXEPU/6W/F/CBS/WH	AXP OtticaUniversale 6W LED 775 lm IP65 for central battery colore Bianco	144,19 €
	AXEPC/3W/F/CBS/WH	AXP Ottica per corridoi 3W LED 460 lm IP65 for central battery colore Bianco	125,05 €
	AXEPC/4W/F/CBS/WH	AXP Ottica per corridoi 4W LED 550 lm IP65 for central battery colore Bianco	127,36 €
	AXEPC/6W/F/CBS/WH	AXP Ottica per corridoi 6W LED 775 lm IP65 for central battery colore Bianco	144,19 €
	AXEPR/3W/F/CBS/WH	AXP Ottica per vie di fuga 3W LED 460 lm IP65 for central battery colore Bianco	125,05 €
	AXEPR/4W/F/CBS/WH	AXP Otticaper vie di fuga 4W LED 550 lm IP65 for central battery colore Bianco	127,36 €
	AXEPR/6W/F/CBS/WH	AXP Otticaper vie di fuga 6W LED 775 lm IP65 for central battery colore Bianco	144,19 €

LEGGENDA:

SE	Emergenza	E	Apparecchio autonomo con elettronica tipo STANDARD
SA	Emergenza + SA	C	Apparecchio autonomo con elettronica tipo STANDARD
AT	autotest	B	Apparecchio autonomo con elettronica tipo PREMIUM
CB	central battery	F	Apparecchio NON AUTONOMO - Alimentazione centralizzata



MICRO SPOT



AC
220-240V
50-60Hz

DC
176-275V

DC
24V

DC
48V

LED

IP20

IK08



MATERIALI	Corpo Bianco, Grigio o Nero in policarbonato
MONTAGGIO	Incasso
ALIMENTAZIONE	Autonoma – 220 - 240VAC/50 - 60Hz Central battery – 220 - 240VAC/50 - 60Hz; 176 - 275VDC Central battery FZLV II – 48VDC * Central battery FZLV – 24VDC *
SORGENTE LUMINOSA	1W, 2W, 3W LED Ottica: U – universale • R – vie di fuga
RICARICA	Standard: max. 24h Premium: max. 12h; charger a risparmio energetico
AUTONOMIA E BATTERIE	Standard: 1h o 3h, Ni-Cd 3,6V batteria Premium: 1h o 3h, LiFePO ₄ 6,4V batteria
CLASSE	II o III
GRADO IP & IK	IP20, IK08
TEMPERATURA	Autonoma: t _a : 0°C ÷ 40°C Central battery: t _a : 0°C ÷ 50°C
OPZIONI	SE – Solo emergenza • SA – sempre accesa • AT – autotest • CB – central battery • Versioni central test RUBIC o alimentazione e controllo centralizzato *
INFORMAZIONI	LED indicazione stato alimentazione e ricarica batteria • Protezione contro scarica profonda • Classe di isolamento III per versione FZLV e FZLV2

* su richiesta

DIMENSIONI [mm]

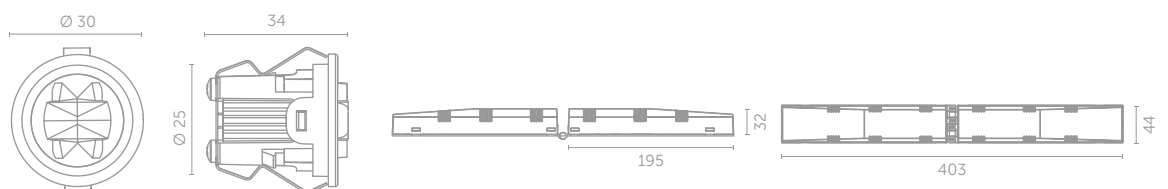

	CODICE ORDINE	MICRO SPOT	LISTINO
		IP20	
STANDARD	MSU/1W/E/1/SE/X/WH	MICRO SPOT con Ottica Universale 1W LED 170 lm STANDARD IP20 1h autonomia, SE, colore Bianco	60,21 €
	MSU/1W/E/3/SE/X/WH	MICRO SPOT con Ottica Universale 1W LED 170 lm STANDARD IP20 3h autonomia, SE, colore Bianco	63,30 €
	MSU/2W/E/1/SE/X/WH	MICRO SPOT con Ottica Universale 2W LED 290 lm STANDARD IP20 1h autonomia, SE, colore Bianco	91,10 €
	MSU/2W/C/3/SE/X/WH	MICRO SPOT con Ottica Universale 2W LED 290 lm STANDARD IP20 3h autonomia, SE, colore Bianco	109,62 €
	MSU/3W/E/1/SE/X/WH	MICRO SPOT con Ottica Universale 3W LED 400 lm STANDARD IP20 1h autonomia, SE, colore Bianco	97,27 €
	MSU/3W/C/3/SE/X/WH	MICRO SPOT con Ottica Universale 3W LED 400 lm STANDARD IP20 3h autonomia, SE, colore Bianco	118,89 €
	MSU/1W/C/1/SA/X/WH	MICRO SPOT con Ottica Universale 1W LED 170 lm STANDARD IP20 1h autonomia, SE + SA, colore Bianco	67,93 €
	MSU/1W/C/3/SA/X/WH	MICRO SPOT con Ottica Universale 1W LED 170 lm STANDARD IP20 3h autonomia, SE + SA, colore Bianco	71,02 €
	MSU/2W/C/1/SA/X/WH	MICRO SPOT con Ottica Universale 2W LED 290 lm STANDARD IP20 1h autonomia, SE + SA, colore Bianco	98,82 €
	MSU/2W/C/3/SA/X/WH	MICRO SPOT con Ottica Universale 2W LED 290 lm STANDARD IP20 3h autonomia, SE + SA, colore Bianco	117,34 €
	MSU/3W/C/1/SA/X/WH	MICRO SPOT con Ottica Universale 3W LED 400 lm STANDARD IP20 1h autonomia, SE + SA, colore Bianco	104,99 €
	MSU/3W/C/3/SA/X/WH	MICRO SPOT con Ottica Universale 3W LED 400 lm STANDARD IP20 3h autonomia, SE + SA, colore Bianco	126,61 €
	MSR/1W/E/1/SE/X/WH	MICRO SPOT Ottica per vie di Fuga 1W LED 165 lm STANDARD IP20 1h autonomia, SE, colore Bianco	60,21 €
	MSR/1W/E/3/SE/X/WH	MICRO SPOT Ottica per vie di Fuga 1W LED 165 lm STANDARD IP20 3h autonomia, SE, colore Bianco	63,30 €
	MSR/2W/E/1/SE/X/WH	MICRO SPOT Ottica per vie di Fuga 2W LED 280 lm STANDARD IP20 1h autonomia, SE, colore Bianco	91,10 €
	MSR/2W/C/3/SE/X/WH	MICRO SPOT Ottica per vie di Fuga 2W LED 280 lm STANDARD IP20 3h autonomia, SE, colore Bianco	109,62 €
	MSR/3W/E/1/SE/X/WH	MICRO SPOT Ottica per vie di Fuga 3W LED 385 lm STANDARD IP20 1h autonomia, SE, colore Bianco	97,27 €
	MSR/3W/C/3/SE/X/WH	MICRO SPOT Ottica per vie di Fuga 3W LED 385 lm STANDARD IP20 3h autonomia, SE, colore Bianco	118,89 €
	MSR/1W/C/1/SA/X/WH	MICRO SPOT Ottica per vie di Fuga 1W LED 165 lm STANDARD IP20 1h autonomia, SE + SA, colore Bianco	67,93 €
	MSR/1W/C/3/SA/X/WH	MICRO SPOT Ottica per vie di Fuga 1W LED 165 lm STANDARD IP20 3h autonomia, SE + SA, colore Bianco	71,02 €
MSR/2W/C/1/SA/X/WH	MICRO SPOT Ottica per vie di Fuga 2W LED 280 lm STANDARD IP20 1h autonomia, SE + SA, colore Bianco	98,82 €	
MSR/2W/C/3/SA/X/WH	MICRO SPOT Ottica per vie di Fuga 2W LED 280 lm STANDARD IP20 3h autonomia, SE + SA, colore Bianco	117,34 €	
MSR/3W/C/1/SA/X/WH	MICRO SPOT Ottica per vie di Fuga 3W LED 385 lm STANDARD IP20 1h autonomia, SE + SA, colore Bianco	104,99 €	
MSR/3W/C/3/SA/X/WH	MICRO SPOT Ottica per vie di Fuga 3W LED 385 lm STANDARD IP20 3h autonomia, SE + SA, colore Bianco	126,61 €	
PREMIUM AUTOTEST	MSU/1W/B/1/SE/AT/WH	MICRO SPOT con Ottica Universale 1W LED 185 lm PREMIUM IP20 1h autonomia, SE, con AUTOTEST, colore Bianco	91,10 €
	MSU/1W/B/3/SE/AT/WH	MICRO SPOT con Ottica Universale 1W LED 185 lm PREMIUM IP20 3h autonomia, SE, con AUTOTEST, colore Bianco	94,18 €
	MSU/2W/B/1/SE/AT/WH	MICRO SPOT con Ottica Universale 2W LED 345 lm PREMIUM IP20 1h autonomia, SE, con AUTOTEST, colore Bianco	100,37 €
	MSU/2W/B/3/SE/AT/WH	MICRO SPOT con Ottica Universale 2W LED 345 lm PREMIUM IP20 3h autonomia, SE, con AUTOTEST, colore Bianco	118,89 €
	MSU/3W/B/1/SE/AT/WH	MICRO SPOT con Ottica Universale 3W LED 460 lm PREMIUM IP20 1h autonomia, SE, con AUTOTEST, colore Bianco	103,45 €
	MSU/3W/B/3/SE/AT/WH	MICRO SPOT con Ottica Universale 3W LED 460 lm PREMIUM IP20 3h autonomia, SE, con AUTOTEST, colore Bianco	125,06 €
	MSU/1W/B/1/SA/AT/WH	MICRO SPOT con Ottica Universale 1W LED 185 lm PREMIUM IP20 1h autonomia, SE + SA, con AUTOTEST, colore Bianco	98,82 €
	MSU/1W/B/3/SA/AT/WH	MICRO SPOT con Ottica Universale 1W LED 185 lm PREMIUM IP20 3h autonomia, SE + SA, con AUTOTEST, colore Bianco	101,90 €
	MSU/2W/B/1/SA/AT/WH	MICRO SPOT con Ottica Universale 2W LED 345 lm PREMIUM IP20 1h autonomia, SE + SA, con AUTOTEST, colore Bianco	108,07 €
	MSU/2W/B/3/SA/AT/WH	MICRO SPOT con Ottica Universale 2W LED 345 lm PREMIUM IP20 3h autonomia, SE + SA, con AUTOTEST, colore Bianco	126,61 €
	MSU/3W/B/1/SA/AT/WH	MICRO SPOT con Ottica Universale 3W LED 460 lm PREMIUM IP20 1h autonomia, SE + SA, con AUTOTEST, colore Bianco	111,17 €
	MSU/3W/B/3/SA/AT/WH	MICRO SPOT con Ottica Universale 3W LED 460 lm PREMIUM IP20 3h autonomia, SE + SA, con AUTOTEST, colore Bianco	132,78 €
	MSR/1W/B/1/SE/AT/WH	MICRO SPOT Ottica per vie di Fuga 1W LED 175 lm PREMIUM IP20 1h autonomia, SE, con AUTOTEST, colore Bianco	91,10 €
	MSR/1W/B/3/SE/AT/WH	MICRO SPOT Ottica per vie di Fuga 1W LED 175 lm PREMIUM IP20 3h autonomia, SE, con AUTOTEST, colore Bianco	94,18 €
	MSR/2W/B/1/SE/AT/WH	MICRO SPOT Ottica per vie di Fuga 2W LED 410 lm PREMIUM IP20 1h autonomia, SE, con AUTOTEST, colore Bianco	100,37 €
	MSR/2W/B/3/SE/AT/WH	MICRO SPOT Ottica per vie di Fuga 2W LED 410 lm PREMIUM IP20 3h autonomia, SE, con AUTOTEST, colore Bianco	118,89 €
	MSR/3W/B/1/SE/AT/WH	MICRO SPOT Ottica per vie di Fuga 3W LED 460 lm PREMIUM IP20 1h autonomia, SE, con AUTOTEST, colore Bianco	103,45 €
	MSR/3W/B/3/SE/AT/WH	MICRO SPOT Ottica per vie di Fuga 3W LED 460 lm PREMIUM IP20 3h autonomia, SE, con AUTOTEST, colore Bianco	125,06 €
	MSR/1W/B/1/SA/AT/WH	MICRO SPOT Ottica per vie di Fuga 1W LED 175 lm PREMIUM IP20 1h autonomia, SE + SA, con AUTOTEST, colore Bianco	98,82 €
	MSR/1W/B/3/SA/AT/WH	MICRO SPOT Ottica per vie di Fuga 1W LED 175 lm PREMIUM IP20 3h autonomia, SE + SA, con AUTOTEST, colore Bianco	101,90 €
MSR/2W/B/1/SA/AT/WH	MICRO SPOT Ottica per vie di Fuga 2W LED 410 lm PREMIUM IP20 1h autonomia, SE + SA, con AUTOTEST, colore Bianco	108,07 €	
MSR/2W/B/3/SA/AT/WH	MICRO SPOT Ottica per vie di Fuga 2W LED 410 lm PREMIUM IP20 3h autonomia, SE + SA, con AUTOTEST, colore Bianco	126,61 €	
MSR/3W/B/1/SA/AT/WH	MICRO SPOT Ottica per vie di Fuga 3W LED 460 lm PREMIUM IP20 1h autonomia, SE + SA, con AUTOTEST, colore Bianco	111,17 €	
MSR/3W/B/3/SA/AT/WH	MICRO SPOT Ottica per vie di Fuga 3W LED 460 lm PREMIUM IP20 3h autonomia, SE + SA, con AUTOTEST, colore Bianco	132,78 €	

	CODICE ORDINE	MICRO SPOT	LISTINO
		IP20	
CENTRAL BATTERY	MSU/1W/F/CB/CBS/WH	MICRO SPOT Ottica universale 1W LED 185 lm IP20 for central battery non-addressable colore bianco	101,58 €
	MSU/2W/F/CB/CBS/WH	MICRO SPOT Ottica universale 2W LED 345 lm IP20 for central battery non-addressable colore bianco	113,08 €
	MSU/3W/F/CB/CBS/WH	MICRO SPOT Ottica universale 3W LED 460 lm IP20 for central battery non-addressable colore bianco	116,92 €
	MSR/1W/F/CB/CBS/WH	MICRO SPOT Ottica vie di fuga 1W LED 185 lm IP20 for central battery non-addressable colore bianco	101,58 €
	MSR/2W/F/CB/CBS/WH	MICRO SPOT Ottica vie di fuga 2W LED 345 lm IP20 for central battery non-addressable colore bianco	113,08 €
	MSR/3W/F/CB/CBS/WH	MICRO SPOT Ottica vie di fuga 3W LED 460 lm IP20 for central battery non-addressable colore bianco	116,92 €

LEGGENDA:

SE	Emergenza	E	Apparecchio autonomo con elettronica tipo STANDARD
SA	Emergenza + SA	C	Apparecchio autonomo con elettronica tipo STANDARD
AT	autotest	B	Apparecchio autonomo con elettronica tipo PREMIUM
CB	central battery	F	Apparecchio NON AUTONOMO - Alimentazione centralizzata



MICRO SPOT Round



AC
220-240V
50-60Hz

DC
176-275V

DC
24V

DC
48V

LED

IP20

IK08



MATERIALI

Corpo Bianco, Grigio o Nero in policarbonato
Cover in acciaio

MONTAGGIO

Incasso

ALIMENTAZIONE

Autonoma – 220 - 240VAC/50 - 60Hz
Central battery – 220 - 240VAC/50 - 60Hz; 176 - 275VDC
Central battery FZLV II – 48VDC *
Central battery FZLV – 24VDC *

SORGENTE LUMINOSA

1W, 2W, 3W LED
Ottica: U – universale • R – vie di fuga

RICARICA

Standard: max. 24h
Premium: max. 12h; charger a risparmio energetico

AUTONOMIA E BATTERIE

Standard: 1h o 3h, Ni-Cd 3,6V batteria
Premium: 1h o 3h, LiFePO₄ 6,4V batteria

CLASSE

II o III

GRADO IP & IK

IP20, IK08

TEMPERATURA

Autonoma: t_a: 0°C ÷ 40°C
Central battery: t_a: 0°C ÷ 50°C

OPZIONI

SE – Solo emergenza • SA – sempre accesa • AT – autotest • CB – central battery
• Versioni central test RUBIC o alimentazione e controllo centralizzato *

INFORMAZIONI

LED indicazione stato alimentazione e ricarica batteria • Protezione contro scarica profonda
• Classe di isolamento III per versione FZLV e FZLV2

* su richiesta

DIMENSIONI [mm]

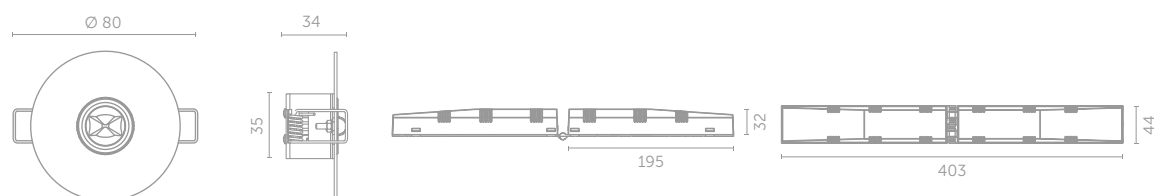

	CODICE ORDINE	MICRO SPOT ROUND	LISTINO
		IP20	
STANDARD	MTRU/1W/E/1/SE/X/WH	MICRO SPOT ROUND con Ottica Universale 1W LED 170 lm STANDARD IP20 1h autonomia, SE, colore Bianco	72,252
	MTRU/1W/E/3/SE/X/WH	MICRO SPOT ROUND con Ottica Universale 1W LED 170 lm STANDARD IP20 3h autonomia, SE, colore Bianco	75,96
	MTRU/2W/E/1/SE/X/WH	MICRO SPOT ROUND con Ottica Universale 2W LED 290 lm STANDARD IP20 1h autonomia, SE, colore Bianco	109,32
	MTRU/2W/C/3/SE/X/WH	MICRO SPOT ROUND con Ottica Universale 2W LED 290 lm STANDARD IP20 3h autonomia, SE, colore Bianco	131,544
	MTRU/3W/E/1/SE/X/WH	MICRO SPOT ROUND con Ottica Universale 3W LED 400 lm STANDARD IP20 1h autonomia, SE, colore Bianco	116,724
	MTRU/3W/C/3/SE/X/WH	MICRO SPOT ROUND con Ottica Universale 3W LED 400 lm STANDARD IP20 3h autonomia, SE, colore Bianco	142,668
	MTRU/1W/C/1/SA/X/WH	MICRO SPOT ROUND con Ottica Universale 1W LED 170 lm STANDARD IP20 1h autonomia, SE + SA, colore Bianco	81,516
	MTRU/1W/C/3/SA/X/WH	MICRO SPOT ROUND con Ottica Universale 1W LED 170 lm STANDARD IP20 3h autonomia, SE + SA, colore Bianco	85,224
	MTRU/2W/C/1/SA/X/WH	MICRO SPOT ROUND con Ottica Universale 2W LED 290 lm STANDARD IP20 1h autonomia, SE + SA, colore Bianco	118,584
	MTRU/2W/C/3/SA/X/WH	MICRO SPOT ROUND con Ottica Universale 2W LED 290 lm STANDARD IP20 3h autonomia, SE + SA, colore Bianco	140,808
	MTRU/3W/C/1/SA/X/WH	MICRO SPOT ROUND con Ottica Universale 3W LED 400 lm STANDARD IP20 1h autonomia, SE + SA, colore Bianco	125,988
	MTRU/3W/C/3/SA/X/WH	MICRO SPOT ROUND con Ottica Universale 3W LED 400 lm STANDARD IP20 3h autonomia, SE + SA, colore Bianco	151,932
	MTRR/1W/E/1/SE/X/WH	MICRO SPOT ROUND con Ottica per vie di fuga 1W LED 165 lm STANDARD IP20 1h autonomia, SE, colore Bianco	72,252
	MTRR/1W/E/3/SE/X/WH	MICRO SPOT ROUND con Ottica per vie di fuga 1W LED 165 lm STANDARD IP20 3h autonomia, SE, colore Bianco	75,96
	MTRR/2W/E/1/SE/X/WH	MICRO SPOT ROUND con Ottica per vie di fuga 2W LED 280 lm STANDARD IP20 1h autonomia, SE, colore Bianco	109,32
	MTRR/2W/C/3/SE/X/WH	MICRO SPOT ROUND con Ottica per vie di fuga 2W LED 280 lm STANDARD IP20 3h autonomia, SE, colore Bianco	131,544
	MTRR/3W/E/1/SE/X/WH	MICRO SPOT ROUND con Ottica per vie di fuga 3W LED 385 lm STANDARD IP20 1h autonomia, SE, colore Bianco	116,724
	MTRR/3W/C/3/SE/X/WH	MICRO SPOT ROUND con Ottica per vie di fuga 3W LED 385 lm STANDARD IP20 3h autonomia, SE, colore Bianco	142,668
	MTRR/1W/C/1/SA/X/WH	MICRO SPOT ROUND con Ottica per vie di fuga 1W LED 165 lm STANDARD IP20 1h autonomia, SE + SA, colore Bianco	81,516
	MTRR/1W/C/3/SA/X/WH	MICRO SPOT ROUND con Ottica per vie di fuga 1W LED 165 lm STANDARD IP20 3h autonomia, SE + SA, colore Bianco	85,224
	MTRR/2W/C/1/SA/X/WH	MICRO SPOT ROUND con Ottica per vie di fuga 2W LED 280 lm STANDARD IP20 1h autonomia, SE + SA, colore Bianco	118,584
	MTRR/2W/C/3/SA/X/WH	MICRO SPOT ROUND con Ottica per vie di fuga 2W LED 280 lm STANDARD IP20 3h autonomia, SE + SA, colore Bianco	140,808
	MTRR/3W/C/1/SA/X/WH	MICRO SPOT ROUND con Ottica per vie di fuga 3W LED 385 lm STANDARD IP20 1h autonomia, SE + SA, colore Bianco	125,988
	MTRR/3W/C/3/SA/X/WH	MICRO SPOT ROUND con Ottica per vie di fuga 3W LED 385 lm STANDARD IP20 3h autonomia, SE + SA, colore Bianco	151,932
PREMIUM AUTOTEST	MTRU/1W/B/1/SE/AT/WH	MICRO SPOT ROUND con Ottica Universale 1W LED 185 lm PREMIUM IP20 1h autonomia, SE, con AUTOTEST, colore Bianco	109,32
	MTRU/1W/B/3/SE/AT/WH	MICRO SPOT ROUND con Ottica Universale 1W LED 185 lm PREMIUM IP20 3h autonomia, SE, con AUTOTEST, colore Bianco	113,016
	MTRU/2W/B/1/SE/AT/WH	MICRO SPOT ROUND con Ottica Universale 2W LED 345 lm PREMIUM IP20 1h autonomia, SE, con AUTOTEST, colore Bianco	120,444
	MTRU/2W/B/3/SE/AT/WH	MICRO SPOT ROUND con Ottica Universale 2W LED 345 lm PREMIUM IP20 3h autonomia, SE, con AUTOTEST, colore Bianco	142,668
	MTRU/3W/B/1/SE/AT/WH	MICRO SPOT ROUND con Ottica Universale 3W LED 460 lm PREMIUM IP20 1h autonomia, SE, con AUTOTEST, colore Bianco	124,14
	MTRU/3W/B/3/SE/AT/WH	MICRO SPOT ROUND con Ottica Universale 3W LED 460 lm PREMIUM IP20 3h autonomia, SE, con AUTOTEST, colore Bianco	150,072
	MTRU/1W/B/1/SA/AT/WH	MICRO SPOT ROUND con Ottica Universale 1W LED 185 lm PREMIUM IP20 1h autonomia, SE + SA, con AUTOTEST, colore Bianco	118,584
	MTRU/1W/B/3/SA/AT/WH	MICRO SPOT ROUND con Ottica Universale 1W LED 185 lm PREMIUM IP20 3h autonomia, SE + SA, con AUTOTEST, colore Bianco	122,28
	MTRU/2W/B/1/SA/AT/WH	MICRO SPOT ROUND con Ottica Universale 2W LED 345 lm PREMIUM IP20 1h autonomia, SE + SA, con AUTOTEST, colore Bianco	129,684
	MTRU/2W/B/3/SA/AT/WH	MICRO SPOT ROUND con Ottica Universale 2W LED 345 lm PREMIUM IP20 3h autonomia, SE + SA, con AUTOTEST, colore Bianco	151,932
	MTRU/3W/B/1/SA/AT/WH	MICRO SPOT ROUND con Ottica Universale 3W LED 460 lm PREMIUM IP20 1h autonomia, SE + SA, con AUTOTEST, colore Bianco	133,404
	MTRU/3W/B/3/SA/AT/WH	MICRO SPOT ROUND con Ottica Universale 3W LED 460 lm PREMIUM IP20 3h autonomia, SE + SA, con AUTOTEST, colore Bianco	159,336
	MTRR/1W/B/1/SE/AT/WH	MICRO SPOT ROUND con Ottica per vie di fuga 1W LED 175 lm PREMIUM IP20 1h autonomia, SE, con AUTOTEST, colore Bianco	109,32
	MTRR/1W/B/3/SE/AT/WH	MICRO SPOT ROUND con Ottica per vie di fuga 1W LED 175 lm PREMIUM IP20 3h autonomia, SE, con AUTOTEST, colore Bianco	113,016
	MTRR/2W/B/1/SE/AT/WH	MICRO SPOT ROUND con Ottica per vie di fuga 2W LED 330 lm PREMIUM IP20 1h autonomia, SE, con AUTOTEST, colore Bianco	120,444
	MTRR/2W/B/3/SE/AT/WH	MICRO SPOT ROUND con Ottica per vie di fuga 2W LED 330 lm PREMIUM IP20 3h autonomia, SE, con AUTOTEST, colore Bianco	142,668
	MTRR/3W/B/1/SE/AT/WH	MICRO SPOT ROUND con Ottica per vie di fuga 3W LED 460 lm PREMIUM IP20 1h autonomia, SE, con AUTOTEST, colore Bianco	124,14
	MTRR/3W/B/3/SE/AT/WH	MICRO SPOT ROUND con Ottica per vie di fuga 3W LED 460 lm PREMIUM IP20 3h autonomia, SE, con AUTOTEST, colore Bianco	150,072
	MTRR/1W/B/1/SA/AT/WH	MICRO SPOT ROUND con Ottica per vie di fuga 1W LED 175 lm PREMIUM IP20 1h autonomia, SE + SA, con AUTOTEST, colore Bianco	118,584
	MTRR/1W/B/3/SA/AT/WH	MICRO SPOT ROUND con Ottica per vie di fuga 1W LED 175 lm PREMIUM IP20 3h autonomia, SE + SA, con AUTOTEST, colore Bianco	122,28
	MTRR/2W/B/1/SA/AT/WH	MICRO SPOT ROUND con Ottica per vie di fuga 2W LED 330 lm PREMIUM IP20 1h autonomia, SE + SA, con AUTOTEST, colore Bianco	129,684
	MTRR/2W/B/3/SA/AT/WH	MICRO SPOT ROUND con Ottica per vie di fuga 2W LED 330 lm PREMIUM IP20 3h autonomia, SE + SA, con AUTOTEST, colore Bianco	151,932
	MTRR/3W/B/1/SA/AT/WH	MICRO SPOT ROUND con Ottica per vie di fuga 3W LED 460 lm PREMIUM IP20 1h autonomia, SE + SA, con AUTOTEST, colore Bianco	133,404
	MTRR/3W/B/3/SA/AT/WH	MICRO SPOT ROUND con Ottica per vie di fuga 3W LED 460 lm PREMIUM IP20 3h autonomia, SE + SA, con AUTOTEST, colore Bianco	159,336

	CODICE ORDINE	MICRO SPOT SQUARE	LISTINO
		IP20	
CENTRAL BATTERY	MTRU/1W/F/CB/CBS/WH	MICRO SPOT ROUND Ottica universale 1W LED 185 lm IP20 for central battery non-addressable colore bianco	121,896
	MTRU/2W/F/CB/CBS/WH	MICRO SPOT ROUND Ottica universale 2W LED 345 lm IP20 for central battery non-addressable colore bianco	135,696
	MTRU/3W/F/CB/CBS/WH	MICRO SPOT ROUND Ottica universale 3W LED 460 lm IP20 for central battery non-addressable colore bianco	140,304
	MTRU/1W/F/CB/CBS/WH	MICRO SPOT ROUND Ottica per vie di fuga 1W LED 175 lm IP20 for central battery colore bianco	121,896
	MTRU/2W/F/CB/CBS/WH	MICRO SPOT ROUND Ottica per vie di fuga 2W LED 330 lm IP20 for central battery colore bianco	135,696
	MTRU/3W/F/CB/CBS/WH	MICRO SPOT ROUND Ottica per vie di fuga 3W LED 460 lm IP20 for central battery colore bianco	140,304

LEGGENDA:

SE	Emergenza	E	Apparecchio autonomo con elettronica tipo STANDARD
SA	Emergenza + SA	C	Apparecchio autonomo con elettronica tipo STANDARD
AT	autotest	B	Apparecchio autonomo con elettronica tipo PREMIUM
CB	central battery	F	Apparecchio NON AUTONOMO - Alimentazione centralizzata



MICRO SPOT Square

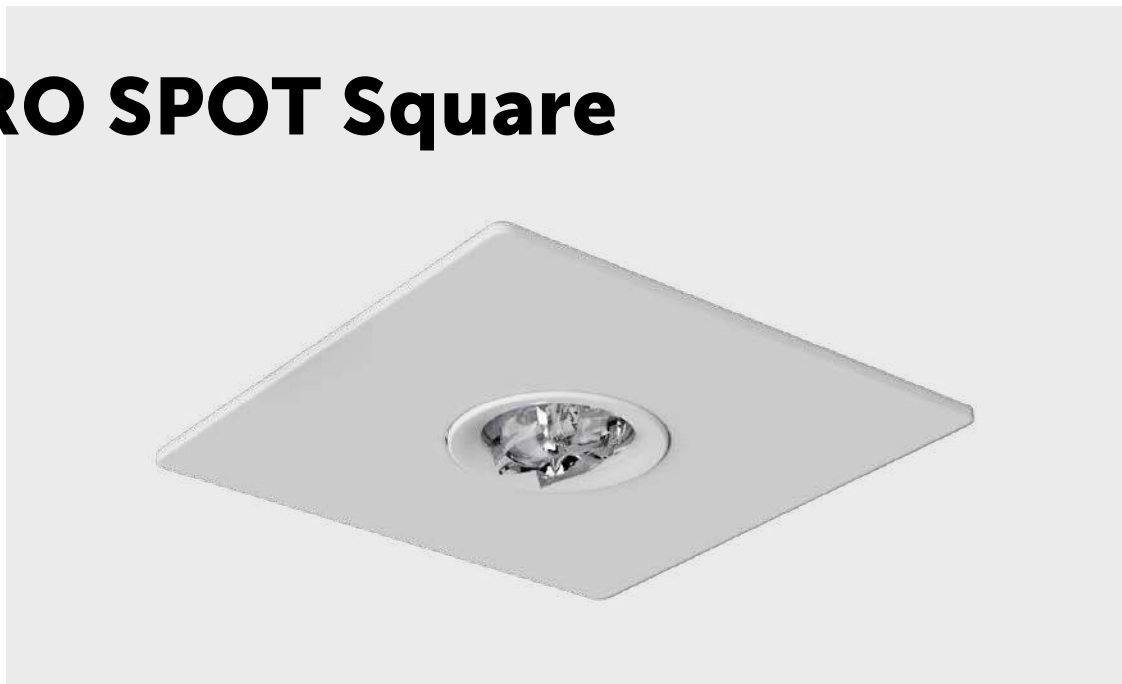

AC
220-240V
50-60Hz

DC
176-275V

DC
24V

DC
48V

LED

IP20

IK08



CE

Ni-Cd

LiFePO₄



MATERIALI

Corpo Bianco, Grigio o Nero in policarbonato policarbonato
Cover in acciaio

MONTAGGIO

Incasso

ALIMENTAZIONE

Autonoma – 220 - 240VAC/50 - 60Hz
Central battery – 220 - 240VAC/50 - 60Hz; 176 - 275VDC
Central battery FZLV II – 48VDC *
Central battery FZLV – 24VDC *

SORGENTE LUMINOSA

1W, 2W, 3W LED
Ottica: U – universale • R – vie di fuga

RICARICA

Standard: max. 24h
Premium: max. 12h; charger a risparmio energetico

AUTONOMIA E BATTERIE

Standard: 1h o 3h, Ni-Cd 3,6V batteria
Premium: 1h o 3h, LiFePO₄ 6,4V batteria

CLASSE

II o III

GRADO IP & IK

IP20, IK08

TEMPERATURA

Autonoma: t_g: 0°C ÷ 40°C **Central battery:** t_g: 0°C ÷ 50°C

OPZIONI

SE – Solo emergenza • SA – sempre accesa • AT – autotest • CB – central battery
• Versioni central test RUBIC o alimentazione e controllo centralizzato *

INFORMAZIONI

LED indicazione stato alimentazione e ricarica batteria • Protezione contro scarica profonda
• Classe di isolamento III per versione FZLV e FZLV2

* su richiesta

DIMENSIONI [mm]

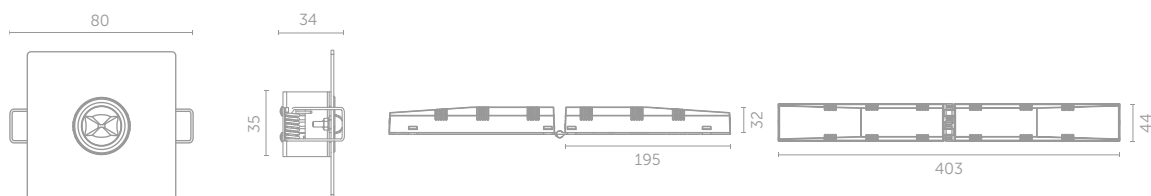

	CODICE ORDINE	MICRO SPOT SQUARE	LISTINO	
		IP20		
STANDARD	MTSU/1W/E/1/SE/X/WH	MICRO SPOT SQUARE con Ottica Universale 1W LED 170 lm STANDARD IP20 1h autonomia, SE, colore Bianco	72,252	
	MTSU/1W/E/3/SE/X/WH	MICRO SPOT SQUARE con Ottica Universale 1W LED 170 lm STANDARD IP20 3h autonomia, SE, colore Bianco	75,96	
	MTSU/2W/E/1/SE/X/WH	MICRO SPOTSQUARE con Ottica Universale 2W LED 290 lm STANDARD IP20 1h autonomia, SE, colore Bianco	109,32	
	MTSU/2W/C/3/SE/X/WH	MICRO SPOTSQUARE con Ottica Universale 2W LED 290 lm STANDARD IP20 3h autonomia, SE, colore Bianco	131,544	
	MTSU/3W/E/1/SE/X/WH	MICRO SPOT SQUARE con Ottica Universale 3W LED 400 lm STANDARD IP20 1h autonomia, SE, colore Bianco	116,724	
	MTSU/3W/C/3/SE/X/WH	MICRO SPOT SQUARE con Ottica Universale 3W LED 400 lm STANDARD IP20 3h autonomia, SE, colore Bianco	142,668	
	MTSU/1W/C/1/SA/X/WH	MICRO SPOT SQUARE con Ottica Universale 1W LED 170 lm STANDARD IP20 1h autonomia, SE + SA, colore Bianco	81,516	
	MTSU/1W/C/3/SA/X/WH	MICRO SPOT SQUARE con Ottica Universale 1W LED 170 lm STANDARD IP20 3h autonomia, SE + SA, colore Bianco	85,224	
	MTSU/2W/C/1/SA/X/WH	MICRO SPOT SQUARE con Ottica Universale 2W LED 290 lm STANDARD IP20 1h autonomia, SE + SA, colore Bianco	118,584	
	MTSU/2W/C/3/SA/X/WH	MICRO SPOTSQUARE con Ottica Universale 2W LED 290 lm STANDARD IP20 3h autonomia, SE + SA, colore Bianco	140,808	
	MTSU/3W/C/1/SA/X/WH	MICRO SPOTSQUARE con Ottica Universale 3W LED 400 lm STANDARD IP20 1h autonomia, SE + SA, colore Bianco	125,988	
	MTSU/3W/C/3/SA/X/WH	MICRO SPOT SQUARE con Ottica Universale 3W LED 400 lm STANDARD IP20 3h autonomia, SE + SA, colore Bianco	151,932	
	MTSR/1W/E/1/SE/X/WH	MICRO SPOT SQUARE con Ottica per vie di fuga 1W LED 165 lm STANDARD IP20 1h autonomia, SE, colore Bianco	72,252	
	MTSR/1W/E/3/SE/X/WH	MICRO SPOT SQUARE con Ottica per vie di fuga 1W LED 165 lm STANDARD IP20 3h autonomia, SE, colore Bianco	75,96	
	MTSR/2W/E/1/SE/X/WH	MICRO SPOT SQUARE con Ottica per vie di fuga 2W LED 280 lm STANDARD IP20 1h autonomia, SE, colore Bianco	109,32	
	MTSR/2W/C/3/SE/X/WH	MICRO SPOT SQUARE con Ottica per vie di fuga 2W LED 280 lm STANDARD IP20 3h autonomia, SE, colore Bianco	131,544	
	MTSR/3W/E/1/SE/X/WH	MICRO SPOT SQUARE con Ottica per vie di fuga 3W LED 385 lm STANDARD IP20 1h autonomia, SE, colore Bianco	116,724	
	MTSR/3W/C/3/SE/X/WH	MICRO SPOT SQUARE con Ottica per vie di fuga 3W LED 385 lm STANDARD IP20 3h autonomia, SE, colore Bianco	142,668	
	MTSR/1W/C/1/SA/X/WH	MICRO SPOTSQUARE con Ottica per vie di fuga 1W LED 165 lm STANDARD IP20 1h autonomia, SE + SA, colore Bianco	81,516	
	MTSR/1W/C/3/SA/X/WH	MICRO SPOT SQUARE con Ottica per vie di fuga 1W LED 165 lm STANDARD IP20 3h autonomia, SE + SA, colore Bianco	85,224	
	MTSR/2W/C/1/SA/X/WH	MICRO SPOT SQUARE con Ottica per vie di fuga 2W LED 280 lm STANDARD IP20 1h autonomia, SE + SA, colore Bianco	118,584	
	MTSR/2W/C/3/SA/X/WH	MICRO SPOT SQUARE con Ottica per vie di fuga 2W LED 280 lm STANDARD IP20 3h autonomia, SE + SA, colore Bianco	140,808	
	MTSR/3W/C/1/SA/X/WH	MICRO SPOT SQUARE con Ottica per vie di fuga 3W LED 385 lm STANDARD IP20 1h autonomia, SE + SA, colore Bianco	125,988	
	MTSR/3W/C/3/SA/X/WH	MICRO SPOT SQUARE con Ottica per vie di fuga 3W LED 385 lm STANDARD IP20 3h autonomia, SE + SA, colore Bianco	151,932	
	PREMIUM AUTOTEST	MTSU/1W/B/1/SE/AT/WH	MICRO SPOT SQUARE con Ottica Universale 1W LED 185 lm PREMIUM IP20 1h autonomia, SE, con AUTOTEST, colore Bianco	109,32
		MTSU/1W/B/3/SE/AT/WH	MICRO SPOT SQUARE con Ottica Universale 1W LED 185 lm PREMIUM IP20 3h autonomia, SE, con AUTOTEST, colore Bianco	113,016
MTSU/2W/B/1/SE/AT/WH		MICRO SPOT SQUARE con Ottica Universale 2W LED 345 lm PREMIUM IP20 1h autonomia, SE, con AUTOTEST, colore Bianco	120,444	
MTSU/2W/B/3/SE/AT/WH		MICRO SPOTSQUARE con Ottica Universale 2W LED 345 lm PREMIUM IP20 3h autonomia, SE, con AUTOTEST, colore Bianco	142,668	
MTSU/3W/B/1/SE/AT/WH		MICRO SPOT SQUARE con Ottica Universale 3W LED 460 lm PREMIUM IP20 1h autonomia, SE, con AUTOTEST, colore Bianco	124,14	
MTSU/3W/B/3/SE/AT/WH		MICRO SPOT SQUARE con Ottica Universale 3W LED 460 lm PREMIUM IP20 3h autonomia, SE, con AUTOTEST, colore Bianco	150,072	
MTSU/1W/B/1/SA/AT/WH		MICRO SPOT SQUARE con Ottica Universale 1W LED 185 lm PREMIUM IP20 1h autonomia, SE + SA, con AUTOTEST, colore Bianco	118,584	
MTSU/1W/B/3/SA/AT/WH		MICRO SPOT SQUARE con Ottica Universale 1W LED 185 lm PREMIUM IP20 3h autonomia, SE + SA, con AUTOTEST, colore Bianco	122,28	
MTSU/2W/B/1/SA/AT/WH		MICRO SPOT SQUARE con Ottica Universale 2W LED 345 lm PREMIUM IP20 1h autonomia, SE + SA, con AUTOTEST, colore Bianco	129,684	
MTSU/2W/B/3/SA/AT/WH		MICRO SPOT SQUARE con Ottica Universale 2W LED 345 lm PREMIUM IP20 3h autonomia, SE + SA, con AUTOTEST, colore Bianco	151,932	
MTSU/3W/B/1/SA/AT/WH		MICRO SPOT SQUARE con Ottica Universale 3W LED 460 lm PREMIUM IP20 1h autonomia, SE + SA, con AUTOTEST, colore Bianco	133,404	
MTSU/3W/B/3/SA/AT/WH		MICRO SPOT SQUARE con Ottica Universale 3W LED 460 lm PREMIUM IP20 3h autonomia, SE + SA, con AUTOTEST, colore Bianco	159,336	
MTSR/1W/B/1/SE/AT/WH		MICRO SPOT SQUARE con Ottica per vie di fuga 1W LED 175 lm PREMIUM IP20 1h autonomia, SE, con AUTOTEST, colore Bianco	109,32	
MTSR/1W/B/3/SE/AT/WH		MICRO SPOT SQUARE con Ottica per vie di fuga 1W LED 175 lm PREMIUM IP20 3h autonomia, SE, con AUTOTEST, colore Bianco	113,016	
MTSR/2W/B/1/SE/AT/WH		MICRO SPOT SQUARE con Ottica per vie di fuga 2W LED 330 lm PREMIUM IP20 1h autonomia, SE, con AUTOTEST, colore Bianco	120,444	
MTSR/2W/B/3/SE/AT/WH		MICRO SPOT SQUARE con Ottica per vie di fuga 2W LED 330 lm PREMIUM IP20 3h autonomia, SE, con AUTOTEST, colore Bianco	142,668	
MTSR/3W/B/1/SE/AT/WH		MICRO SPOT SQUARE con Ottica per vie di fuga 3W LED 460 lm PREMIUM IP20 1h autonomia, SE, con AUTOTEST, colore Bianco	124,14	
MTSR/3W/B/3/SE/AT/WH		MICRO SPOT SQUARE con Ottica per vie di fuga 3W LED 460 lm PREMIUM IP20 3h autonomia, SE, con AUTOTEST, colore Bianco	150,072	
MTSR/1W/B/1/SA/AT/WH		MICRO SPOT SQUARE con Ottica per vie di fuga 1W LED 175 lm PREMIUM IP20 1h autonomia, SE + SA, con AUTOTEST, colore Bianco	118,584	
MTSR/1W/B/3/SA/AT/WH		MICRO SPOT SQUARE con Ottica per vie di fuga 1W LED 175 lm PREMIUM IP20 3h autonomia, SE + SA, con AUTOTEST, colore Bianco	122,28	
MTSR/2W/B/1/SA/AT/WH		MICRO SPOT SQUARE con Ottica per vie di fuga 2W LED 330 lm PREMIUM IP20 1h autonomia, SE + SA, con AUTOTEST, colore Bianco	129,684	
MRSR/2W/B/3/SA/AT/WH		MICRO SPOT SQUARE con Ottica per vie di fuga 2W LED 330 lm PREMIUM IP20 3h autonomia, SE + SA, con AUTOTEST, colore Bianco	151,932	
MTSR/3W/B/1/SA/AT/WH		MICRO SPOT SQUARE con Ottica per vie di fuga 3W LED 460 lm PREMIUM IP20 1h autonomia, SE + SA, con AUTOTEST, colore Bianco	133,404	
MTSR/3W/B/3/SA/AT/WH		MICRO SPOT SQUARE con Ottica per vie di fuga 3W LED 460 lm PREMIUM IP20 3h autonomia, SE + SA, con AUTOTEST, colore Bianco	159,336	

	CODICE ORDINE	MICRO SPOT SQUARE	LISTINO
		IP20	
CENTRAL BATTERY	MTSU/1W/F/CB/CBS/WH	MICRO SPOT SQUARE Ottica universale 1W LED 185 lm IP20 for central battery non-addressable colore bianco	121,896
	MTSU/2W/F/CB/CBS/WH	MICRO SPOT SQUARE Ottica universale 2W LED 345 lm IP20 for central battery non-addressable colore bianco	135,696
	MTSU/3W/F/CB/CBS/WH	MICRO SPOT SQUARE Ottica universale 3W LED 460 lm IP20 for central battery non-addressable colore bianco	140,304
	MTSRR/1W/F/CB/CBS/WH	MICRO SPOT SQUARE Ottica per vi di fuga 1W LED 175 lm IP20 for central battery colore bianco	121,896
	MTSRR/2W/F/CB/CBS/WH	MICRO SPOT SQUARE Ottica per vi di fuga 2W LED 330 lm IP20 for central battery colore bianco	135,696
	MTSRR/3W/F/CB/CBS/WH	MICRO SPOT SQUARE Ottica per vi di fuga 3W LED 460 lm IP20 for central battery colore bianco	140,304

LEGGENDA:

SE	Emergenza	E	Apparecchio autonomo con elettronica tipo STANDARD
SA	Emergenza + SA	C	Apparecchio autonomo con elettronica tipo STANDARD
AT	autotest	B	Apparecchio autonomo con elettronica tipo PREMIUM
CB	central battery	F	Apparecchio NON AUTONOMO - Alimentazione centralizzata



EYE LED Round



AC
220-240V
50-60Hz

DC
176-275V

DC
24V

DC
48V

LED

IP20

IK08



KM 618355
BS-EN 60598-2-22



MATERIALI

Corpo in acciaio inossidabile o disponibile in Bianco

MONTAGGIO

Incasso

ALIMENTAZIONE

Autonoma – 220 - 240VAC/50 - 60Hz
Central battery – 220 - 240VAC/50 - 60Hz; 176 - 275VDC
Central battery FZLV II – 48VDC *
Central battery FZLV – 24VDC *

SORGENTE LUMINOSA

1W, 2W, 3W, 3x1W LED
Ottica: O – open area • U – universale • R – vie di fuga • C - corridoio

RICARICA

Standard: max. 24h
Premium: max. 12h; charger a risparmio energetico

AUTONOMIA E BATTERIE

Standard: 1h o 3h, Ni-Cd 3,6V batteria
Premium: 1h o 3h, LiFePO₄ 6,4V batteria

CLASSE

II o III

GRADO IP & IK

IP20, IK08

TEMPERATURA

Autonoma: t_a: 0°C ÷ 40°C
Central battery: t_a: 0°C ÷ 50°C

OPZIONI

SE – Solo emergenza • SA – sempre accesa • AT – autotest • CB – central battery
• Versioni central test RUBIC o alimentazione e controllo centralizzato *

INFORMAZIONI

LED indicazione stato alimentazione e ricarica batteria • Protezione contro scarica profonda
• Classe di isolamento III per versione FZLV e FZLV2

* su richiesta

DIMENSIONI [mm]

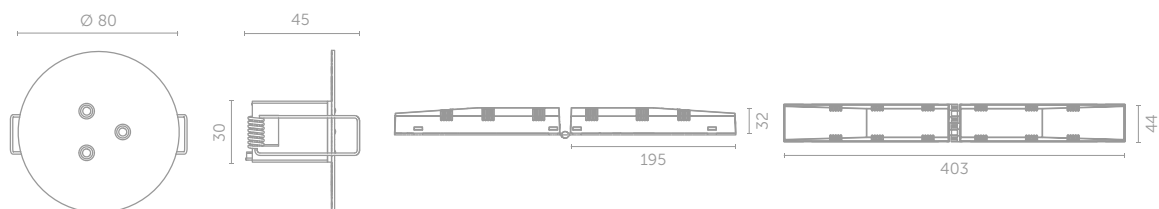

	CODICE ORDINE	EYE LED ROUND	LISTINO
		IP20	
CENTRAL BATTERY	EYO/3W/F/CB/X/ST	EYE LED ROUND Ottica open area 3W IP20 per central battery system acciaio inossidabile	124,97 €
	EYO/3W/F/CB/X/WH	EYE LED ROUND Ottica open area 3W IP20 per central battery system, acciaio inossidabile colore Bianco	124,97 €
	EYU/3W/F/CB/X/ST	EYE LED ROUND con Ottica Universale 3W LED 390 lm IP20 per central battery system acciaio inossidabile	124,97 €
	EYU/3W/F/CB/X/WH	EYE LED ROUND con Ottica Universale 3W LED 390 lm IP20 per central battery system, acciaio inossidabile colore Bianco	124,97 €
	EYC/3W/F/CB/X/ST	EYE LED ROUND Ottica per corridoi 3W IP20 per central battery system acciaio inossidabile	124,97 €
	EYC/3W/F/CB/X/WH	EYE LED ROUND Ottica per corridoi 3W IP20 per central battery system, acciaio inossidabile colore Bianco	124,97 €
	EYR/3W/F/CB/X/ST	EYE LED ROUND con Ottica per vie di fuga 3W LED 390 lm IP20 per central battery system acciaio inossidabile	124,97 €
	EYR/3W/F/CB/X/WH	EYE LED ROUND con Ottica per vie di fuga 3W LED 390 lm IP20 per central battery system, acciaio inossidabile colore Bianco	124,97 €
	EY/3x1W/F/CB/X/ST	EYE LED ROUND 3x1W LED 460 lm PREMIUM IP20 3h autonomia, per central battery system acciaio inossidabile	124,97 €
	EY/3x1W/F/CB/X/WH	EYE LED ROUND 3x1W LED 460 lm PREMIUM IP20 3h autonomia ,per central battery system, acciaio inossidabile colore Bianco	124,97 €

LEGGENDA:

SE	Emergenza	E	Apparecchio autonomo con elettronica tipo STANDARD
SA	Emergenza + SA	C	Apparecchio autonomo con elettronica tipo STANDARD
AT	autotest	B	Apparecchio autonomo con elettronica tipo PREMIUM
CB	central battery	F	Apparecchio NON AUTONOMO - Alimentazione centralizzata



EYE LED Square



AC
220-240V
50-60Hz

DC
176-275V

DC
24V

DC
48V

LED

IP20

IK08



KM 618355
BS-EN 60598-2-22



MATERIALI

Corpo in acciaio inossidabile o disponibile in Bianco

MONTAGGIO

Incasso

ALIMENTAZIONE

Autonoma – 220 - 240VAC/50 - 60Hz
Central battery – 220 - 240VAC/50 - 60Hz; 176 - 275VDC
Central battery FZLV II – 48VDC *
Central battery FZLV – 24VDC *

SORGENTE LUMINOSA

1W, 2W, 3W, 3x1W LED
Ottica: O – open area • U – universale • R – vie di fuga • C - corridoio

RICARICA

Standard: max. 24h
Premium: max. 12h; charger a risparmio energetico

AUTONOMIA E BATTERIE

Standard: 1h o 3h, Ni-Cd 3,6V batteria
Premium: 1h o 3h, LiFePO₄ 6,4V batteria

CLASSE

II o III

GRADO IP & IK

IP20, IK08

TEMPERATURA

Autonoma: t_a: 0°C ÷ 40°C
Central battery: t_a: 0°C ÷ 50°C

OPZIONI

SE – Solo emergenza • SA – sempre accesa • AT – autotest • CB – central battery
• Versioni central test RUBIC o alimentazione e controllo centralizzato *

INFORMAZIONI

LED indicazione stato alimentazione e ricarica batteria • Protezione contro scarica profonda
• Classe di isolamento III per versione FZLV e FZLV2

* su richiesta

DIMENSIONI [mm]

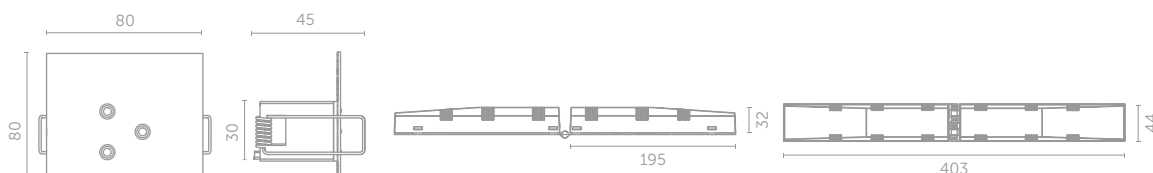

	CODICE ORDINE	EYE LED SQUARE		LISTINO
		IP20		
CENTRAL BATTERY	EYKO/3W/F/CB/X/ST	EYE LED SQUARE Ottica open area 3W 460lm IP20 per central battery system acciaio inossidabile		124,97 €
	EYKO/3W/F/CB/X/WH	EYE LED SQUARE Ottica open area 3W 460lm IP20 per central battery system, colore Bianco		124,97 €
	EYKU/3W/F/CB/X/ST	EYE LED SQUARE Ottica Universale 3W 460lm IP20 per central battery system acciaio inossidabile		124,97 €
	EYKU/3W/F/CB/X/WH	EYE LED SQUARE Ottica Universale 3W 460lm IP20 per central battery system, colore Bianco		124,97 €
	EYKC/3W/F/CB/X/ST	EYE LED SQUARE Ottica per corridoi 3W 460lm IP20 per central battery system acciaio inossidabile		124,97 €
	EYKC/3W/F/CB/X/WH	EYE LED SQUARE Ottica per corridoi 3W 460lm IP20 per central battery system, colore Bianco		124,97 €
	EYKR/3W/F/CB/X/ST	EYE LED SQUARE Ottica per vie di fuga 3W 460lm IP20 per central battery system acciaio inossidabile		124,97 €
	EYKR/3W/F/CB/X/WH	EYE LED SQUARE Ottica per vie di fuga 3W 460lm IP20 per central battery system, colore Bianco		124,97 €
	EYK/3W/F/CB/X/ST	EYE LED SQUARE 3x1W 460lm IP20 per central battery system acciaio inossidabile		124,97 €
	EYK/3W/F/CB/X/WH	EYE LED SQUARE 3x1W 460lm IP20 per central battery system, colore Bianco		124,97 €

LEGGENDA:

SE	Emergenza	E	Apparecchio autonomo con elettronica tipo STANDARD
SA	Emergenza + SA	C	Apparecchio autonomo con elettronica tipo STANDARD
AT	autotest	B	Apparecchio autonomo con elettronica tipo PREMIUM
CB	central battery	F	Apparecchio NON AUTONOMO - Alimentazione centralizzata

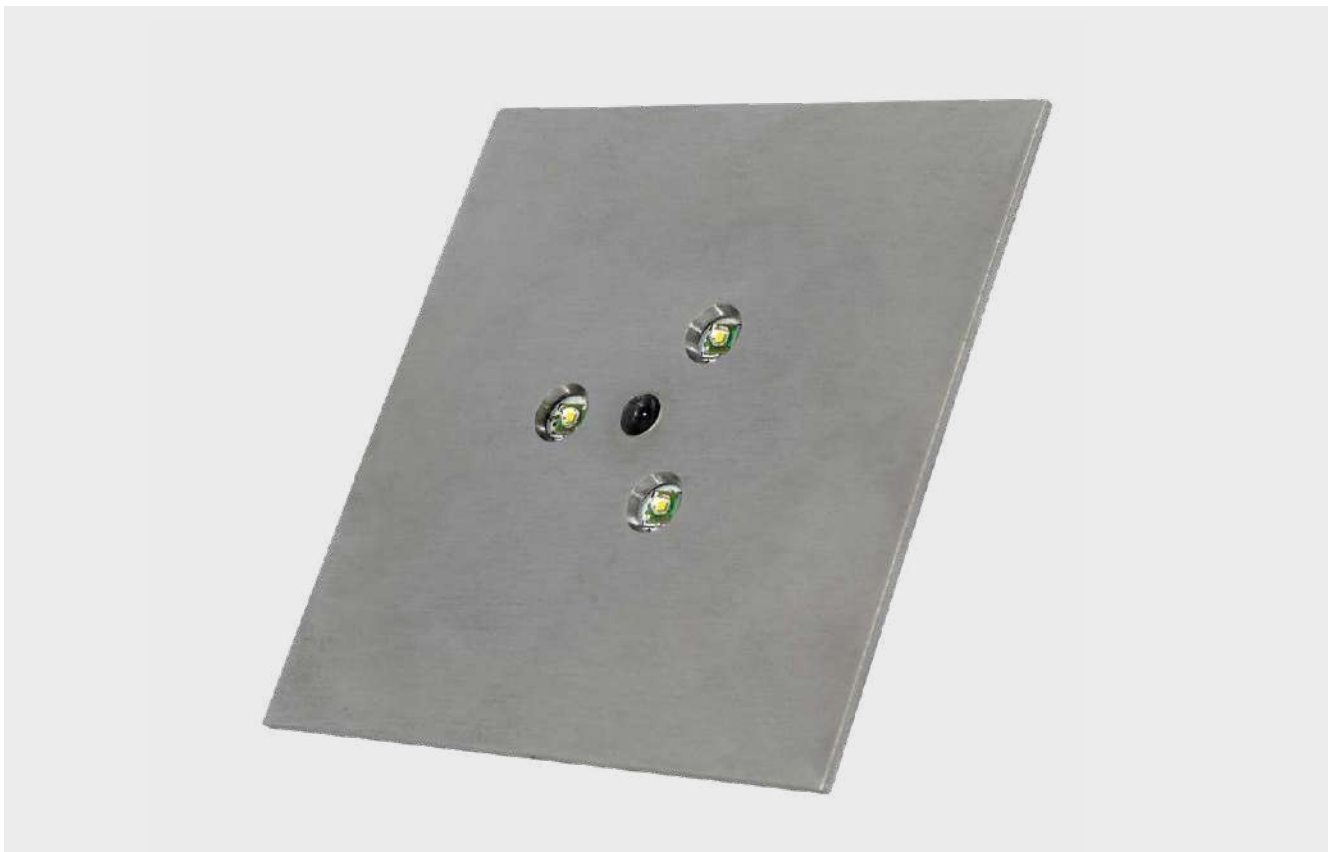

TEY



AC
220-240V
50-60Hz

DC
176-275V

DC
24V

DC
48V

LED

IP20

IK08



CE

Ni-Cd

LiFePO₄



MATERIALI

Alluminio verniciato, Nero o Bianco

MONTAGGIO

Superficie

ALIMENTAZIONE

Autonoma – 220 - 240VAC/50 - 60Hz
Central battery – 220 - 240VAC/50 - 60Hz; 176 - 275VDC
Central battery FZLV II – 48VDC *
Central battery FZLV – 24VDC *

SORGENTE LUMINOSA

1W, 2W, 3W, 3x1W LED
Ottica: O – open area • U – universale • R – vie di fuga • C - corridoio

RICARICA

Standard: max. 24h
Premium: max. 12h; charger a risparmio energetico

AUTONOMIA E BATTERIE

Standard: 1h o 3h, Ni-Cd 3,6V batteria
Premium: 1h o 3h, LiFePO₄ 6,4V batteria

CLASSE

I o III

GRADO IP & IK

IP20, IK08

TEMPERATURA

Autonoma: t_a: 0°C ÷ 40°C
Central battery: t_a: 0°C ÷ 50°C

OPZIONI

SE – Solo emergenza • SA – sempre accesa • AT – autotest • PT – pulsante di test
• CB – central battery • Versioni central test RUBIC o alimentazione e controllo centralizzato *

INFORMAZIONI

LED indicazione stato alimentazione e ricarica batteria • Protezione contro scarica profonda
• III classe di isolamento per versioni FZLV e FZLV II

* su richiesta

DIMENSIONI [mm]

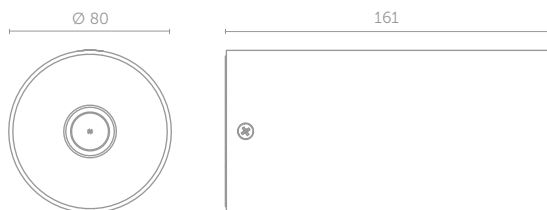

	CODICE ORDINE	TEY	LISTINO
		IP40	
STANDARD	TEY/3x1W/E/1/SE/X/WH	TEY 3x1W LED 390 lm STANDARD IP20 1h autonomia, SE, colore Bianco	159,03 €
	TEY/3x1W/C/3/SE/X/WH	TEY 3x1W LED 390 lm STANDARD IP20 3h autonomia, SE, colore Bianco	180,64 €
	TEY/3x1W/C/1/SA/X/WH	TEY 3x1W LED 390 lm STANDARD IP20 1h autonomia, SE+SA, colore Bianco	166,75 €
	TEY/3x1W/C/3/SA/X/WH	TEY 3x1W LED 390 lm STANDARD IP20 3h autonomia, SE+SA, colore Bianco	188,36 €
	TEYO/3W/E/1/SE/X/WH	TEY Ottica open area 3W LED 380 lm STANDARD IP20 1h autonomia SE colore bianco	164,51 €
	TEYO/3W/C/3/SE/X/WH	TEY Ottica open area 3W LED 380 lm STANDARD IP20 3h autonomia SE colore bianco	186,87 €
	TEYO/3W/C/1/SA/X/WH	TEY Ottica open area 3W LED 380 lm STANDARD IP20 1h autonomia SE + SA colore bianco	172,50 €
	TEYO/3W/C/3/SA/X/WH	TEY Ottica open area 3W LED 380 lm STANDARD IP20 3h autonomia SE + SA colore bianco	194,86 €
	TEYU/3W/E/1/SE/X/WH	TEY Ottica universale 3W LED 410 lm STANDARD IP20 1h autonomia SE colore bianco	164,51 €
	TEYU/3W/C/3/SE/X/WH	TEY Ottica universale 3W LED 410 lm STANDARD IP20 3h autonomia SE colore bianco	186,87 €
	TEYU/3W/C/1/SA/X/WH	TEY Ottica universale 3W LED 410 lm STANDARD IP20 1h autonomia SE + SA colore bianco	172,50 €
	TEYU/3W/C/3/SA/X/WH	TEY Ottica universale 3W LED 410 lm STANDARD IP20 3h autonomia SE + SA colore bianco	194,86 €
	TEYR/3W/E/1/SE/X/WH	TEY Ottica per vie di fuga 3W LED 380 lm STANDARD IP20 1h autonomia SE colore bianco	164,51 €
	TEYR/3W/C/3/SE/X/WH	TEY Ottica per vie di fuga 3W LED 380 lm STANDARD IP20 3h autonomia SE colore bianco	186,87 €
	TEYR/3W/C/1/SA/X/WH	TEY Ottica per vie di fuga 3W LED 380 lm STANDARD IP20 1h autonomia SE + SA colore bianco	172,50 €
	TEYR/3W/C/3/SA/X/WH	TEY Ottica per vie di fuga 3W LED 380 lm STANDARD IP20 3h autonomia SE + SA colore bianco	194,86 €
PREMIUM	TEY/3x1W/E/1/SE/X/WH	TEY 3x1W LED 390 lm STANDARD IP20 1h autonomia, SE, colore Bianco	159,03 €
	TEY/3x1W/C/3/SE/X/WH	TEY 3x1W LED 390 lm STANDARD IP20 3h autonomia, SE, colore Bianco	180,64 €
	TEY/3x1W/C/1/SA/X/WH	TEY 3x1W LED 390 lm STANDARD IP20 1h autonomia, SE+SA, colore Bianco	166,75 €
	TEY/3x1W/C/3/SA/X/WH	TEY 3x1W LED 390 lm STANDARD IP20 3h autonomia, SE+SA, colore Bianco	188,36 €
	TEYO/3W/E/1/SE/X/WH	TEY Ottica open area 3W LED 380 lm STANDARD IP20 1h autonomia SE colore bianco	164,51 €
	TEYO/3W/C/3/SE/X/WH	TEY Ottica open area 3W LED 380 lm STANDARD IP20 3h autonomia SE colore bianco	186,87 €
	TEYO/3W/C/1/SA/X/WH	TEY Ottica open area 3W LED 380 lm STANDARD IP20 1h autonomia SE + SA colore bianco	172,50 €
	TEYO/3W/C/3/SA/X/WH	TEY Ottica open area 3W LED 380 lm STANDARD IP20 3h autonomia SE + SA colore bianco	194,86 €
	TEYU/3W/E/1/SE/X/WH	TEY Ottica universale 3W LED 410 lm STANDARD IP20 1h autonomia SE colore bianco	164,51 €
	TEYU/3W/C/3/SE/X/WH	TEY Ottica universale 3W LED 410 lm STANDARD IP20 3h autonomia SE colore bianco	186,87 €
	TEYU/3W/C/1/SA/X/WH	TEY Ottica universale 3W LED 410 lm STANDARD IP20 1h autonomia SE + SA colore bianco	172,50 €
	TEYU/3W/C/3/SA/X/WH	TEY Ottica universale 3W LED 410 lm STANDARD IP20 3h autonomia SE + SA colore bianco	194,86 €
	TEYR/3W/E/1/SE/X/WH	TEY Ottica per vie di fuga 3W LED 380 lm STANDARD IP20 1h autonomia SE colore bianco	164,51 €
	TEYR/3W/C/3/SE/X/WH	TEY Ottica per vie di fuga 3W LED 380 lm STANDARD IP20 3h autonomia SE colore bianco	186,87 €
	TEYR/3W/C/1/SA/X/WH	TEY Ottica per vie di fuga 3W LED 380 lm STANDARD IP20 1h autonomia SE + SA colore bianco	172,50 €
	TEYR/3W/C/3/SA/X/WH	TEY Ottica per vie di fuga 3W LED 380 lm STANDARD IP20 3h autonomia SE + SA colore bianco	194,86 €

LEGGENDA:

SE	Emergenza	E	Apparecchio autonomo con elettronica tipo STANDARD
SA	Emergenza + SA	C	Apparecchio autonomo con elettronica tipo STANDARD
AT	autotest	B	Apparecchio autonomo con elettronica tipo PREMIUM
CB	central battery	F	Apparecchio NON AUTONOMO - Alimentazione centralizzata



NOVITA' MX



AC
220-240V
50-60Hz

DC
176-275V

DC
48V

LED

IP42

IP65

IK08

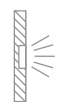

CE



KM 618355
BS-EN 60598-2-22

MATERIALI

Corpo in alluminio anodizzato disponibile in Bianco, Grigio o Nero.
Vetro temperato

MONTAGGIO

Superficie
Opzione incasso ⁽¹⁾

ALIMENTAZIONE

Central battery – 220 - 240VAC/50 - 60Hz; 176 - 275VDC

SORGENTE LUMINOSA

12W – 1360 lm; 15W – 2259 lm
Ottica: C – corridoio • O – open area

CLASSE

I

GRADO IP & IK

IP42 o IP65, IK08

TEMPERATURA

t_a : 0°C ÷ 50°C

OPZIONI

CB – central battery

INFORMAZIONI

⁽¹⁾ vedi accessori per montaggio a incasso

* Codice e prezzo a richiesta

DIMENSIONI [mm]

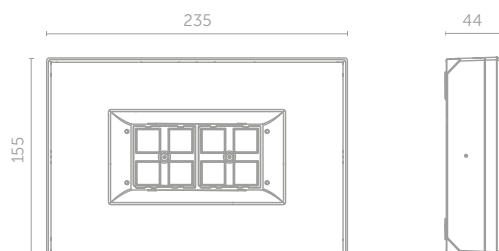

MX accessori



ACCESSORIO PER INCASSO NEL CONTROSOFFITTO

CODICE: MX/REC/WH

MX/REC/GR

MX/REC/BL

DIMENSIONI [mm]

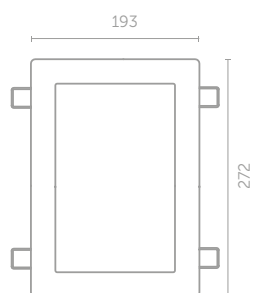

ADATTABILE A MX



OUTDOOR LED

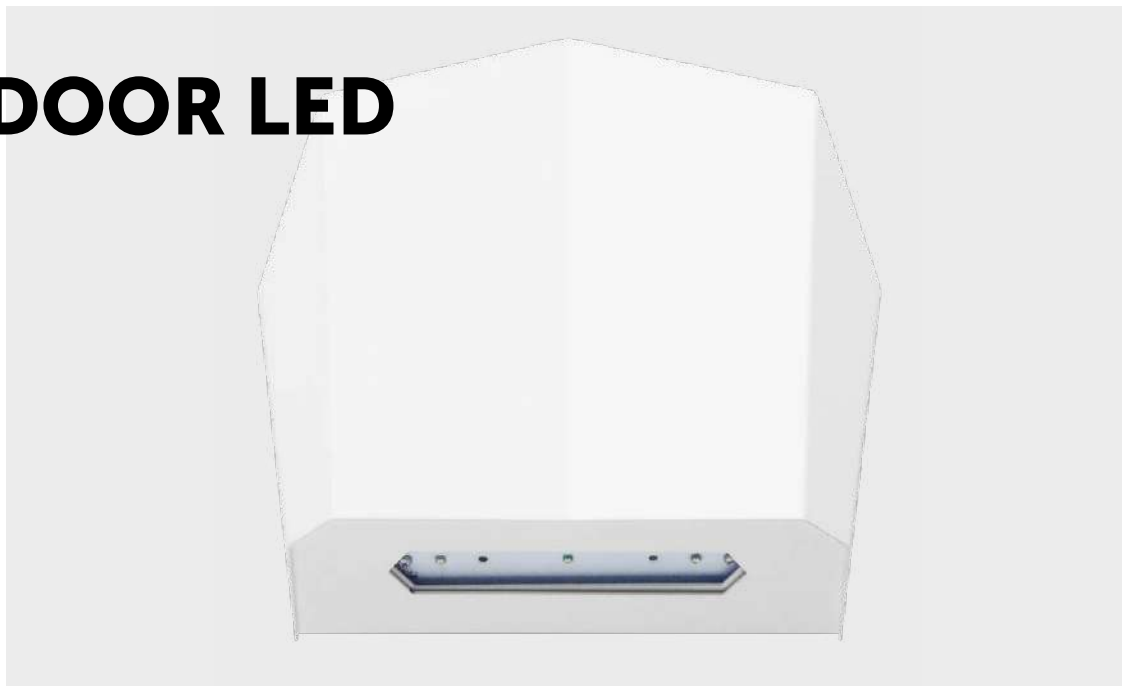

AC
220-240V
50-60Hz

DC
176-275V

DC
24V

DC
48V

LED

IP66

IK10

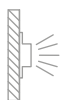

MATERIALI

Stainless steel painted bianco, grigio o nero

MONTAGGIO

Superficie

ALIMENTAZIONE

Autonoma – 220 - 240VAC/50 - 60Hz
Central battery – 220 - 240VAC/50 - 60Hz; 176 - 275VDC
Central battery FZLV II – 48VDC *
Central battery FZLV – 24VDC *

SORGENTE LUMINOSA

3x1W LED
Temperatura colore: 6000K
Lifetime: 50000h

RICARICA

Standard: max. 24h
Premium: max. 12h; charger a risparmio energetico

AUTONOMIA E BATTERIE

Standard: 1h o 3h, Ni-Cd 3,6V batteria
Premium: 1h o 3h, LiFePO₄ 6,4V batteria

CLASSE

I o III

GRADO IP & IK

IP66, IK10

TEMPERATURA

Autonoma: t_a: 0°C ÷ 40°C • t_a: -25°C ÷ 40°C – con sistema per gestione alle basse temperature

OPZIONI

SE – Solo emergenza • SA – sempre accesa • AT – autotest • PT – pulsante di test
• CB – central battery • Versioni central test RUBIC o alimentazione e controllo centralizzato *

INFORMAZIONI

LED indicazione stato alimentazione e ricarica batteria • Protezione contro scarica profonda
• Opzione con adattatore per la gestione alla basse temperature fino a -25°C con HTR 25
• Classe di isolamento III per versione FZLV e FZLV2

* su richiesta

DIMENSIONI [mm]

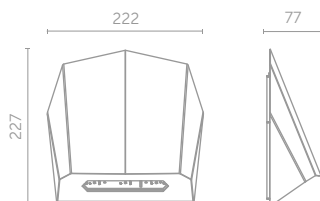

	CODICE ORDINE	OUTDOOR	LISTINO
		IP66	
STANDARD	ODB/3x1W/C/1/SE/X/WH	OUTDOOR 3x1W LED 410 lm STANDARD IP66 1h autonomia, SE, colore Bianco	130,43 €
	ODB/3x1W/C/3/SE/X/WH	OUTDOOR 3x1W LED 410 lm STANDARD IP66 3h autonomia, SE, colore Bianco	148,98 €
	ODB/3x1W/C/1/SA/X/WH	OUTDOOR 3x1W LED 410 lm STANDARD IP66 1h autonomia, SE + SA, colore Bianco	132,72 €
	ODB/3x1W/C/3/SA/X/WH	OUTDOOR 3x1W LED 410 lm STANDARD IP66 3h autonomia, SE + SA, colore Bianco	151,28 €
PREMIUM CON AUTOTEST	ODB/3x1W/B/1/SE/AT/WH	OUTDOOR 3x1W LED 460 lm PREMIUM IP66 1h autonomia, SE, con AUTOTEST, colore Bianco	140,47 €
	ODB/3x1W/B/3/SE/AT/WH	OUTDOOR 3x1W LED 460 lm PREMIUM IP66 3h autonomia, SE, con AUTOTEST, colore Bianco	156,17 €
	ODB/3x1W/B/1/SA/AT/WH	OUTDOOR 3x1W LED 460 lm PREMIUM IP66 1h autonomia, SE + SA, con AUTOTEST, colore Bianco	142,77 €
	ODB/3x1W/B/3/SA/AT/WH	OUTDOOR 3x1W LED 460 lm PREMIUM IP66 3h autonomia, SE + SA, con AUTOTEST, colore Bianco	158,47 €
CENTRAL BATTERY	ODB/3x1W/F/CB/X/WH	OUTDOOR 3x1W LED 460 lm IP66 per central battery system, colore Bianco	140,47 €

LEGGENDA:

SE	Emergenza	E	Apparecchio autonomo con elettronica tipo STANDARD
SA	Emergenza + SA	C	Apparecchio autonomo con elettronica tipo STANDARD
AT	autotest	B	Apparecchio autonomo con elettronica tipo PREMIUM
CB	central battery	F	Apparecchio NON AUTONOMO - Alimentazione centralizzata



EDGE R

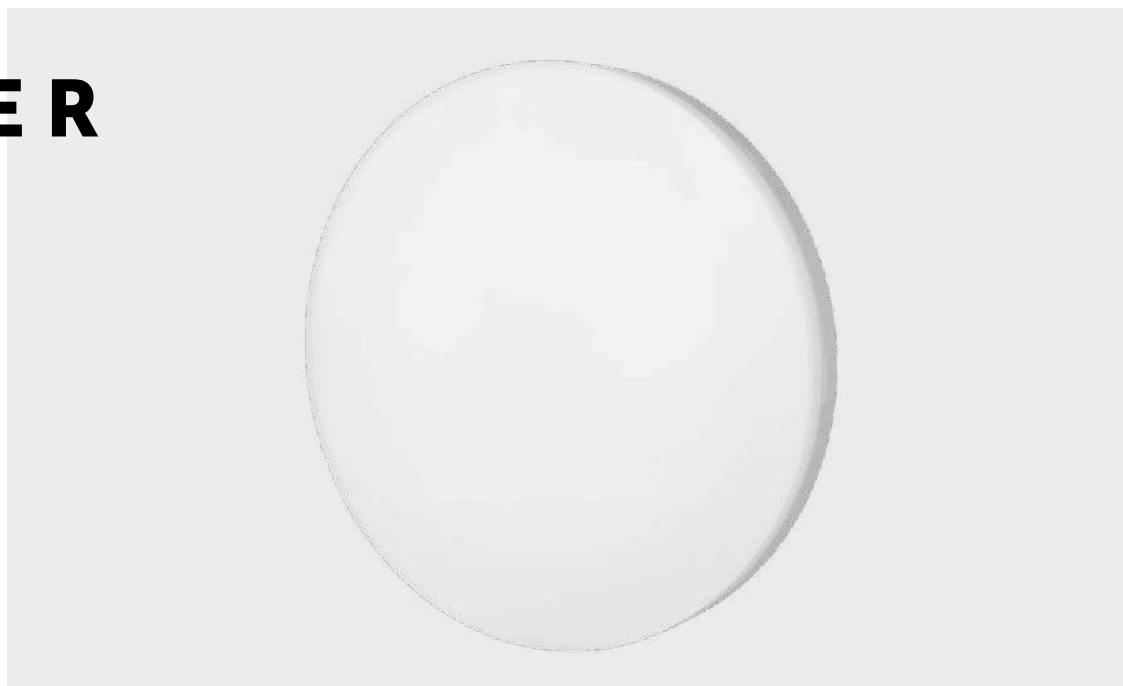

AC
220-240V
50-60Hz

DC
176-275V

DC
24V

DC
48V

LED

IP54

IK10



MATERIALI

Corpo Bianco in policarbonato • Cover in policarbonato opale

MONTAGGIO

Superficie

ALIMENTAZIONE

Autonoma – 220 - 240VAC/50 - 60Hz
Central battery – 220 - 240VAC/50 - 60Hz; 176 - 275VDC
Central battery FZLV II – 48VDC *
Central battery FZLV – 24VDC *

SORGENTE LUMINOSA - MAINS MODE

Power: 12W, 18W, 24W LED
Temperatura colore: 3000K,

SORGENTE LUMINOSA - EMERGENCY MODE

Power: 1W, 3W LED
Temperatura colore: 6500K

RICARICA

Standard: max. 24h
Premium: max. 12h; charger a risparmio energetico

AUTONOMIA E BATTERIE

Standard: 1h o 3h, Ni-Cd 3,6V batteria
Premium: 1h o 3h, LiFePO₄ 6,4V batteria

CLASSE

II

GRADO IP & IK

IP54, IK10

TEMPERATURA

Autonoma: t_a: 0°C ÷ 40°C • t_a: -25°C ÷ 40°C – – con sistema per gestione alle basse temperature
Central battery: t_a: 0°C ÷ 50°C

OPZIONI

SE – Solo emergenza • SA – sempre accesa • AT – autotest • PT – pulsante di test
• CB – central battery • Versioni central test RUBIC o alimentazione e controllo centralizzato *

INFORMAZIONI

LED indicazione stato alimentazione e ricarica batteria • Protezione contro scarica profonda
• Optional apparecchio con il sensore di presenza MCR • Opzione con adattatore per la gestione alla basse temperature fino a -25°C con HTR 25

* su richiesta

DIMENSIONI [mm]

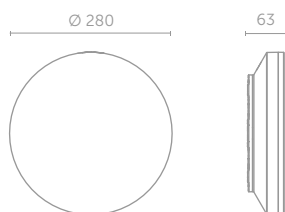

	CODICE ORDINE	EDGE ROUND	LISTINO
		IP54	
ILLUMINAZIONE	EDRE12/WH/3000	EDGE R IP54 12W LED 3000K 1295lm Illuminazione	58,94 €
	EDRE12/WH/4000	EDGE R IP54 12W LED 4000K 1390lm Illuminazione	58,94 €
	EDRE12/WS/3000	EDGE R IP54 12W LED 3000K 1295lm Illuminazione con sensore di presenza MCR	84,82 €
	EDRE12/WS/4000	EDGE R IP54 12W LED 4000K 1390lm Illuminazione con sensore di presenza MCR	84,82 €
	EDRE18/WH/3000	EDGE R IP54 18W LED 3000k 2080lm Illuminazione	70,44 €
	EDRE18/WH/4000	EDGE R IP54 18W LED 4000K 2170lm Illuminazione	70,44 €
	EDRE18/WS/3000	EDGE R IP54 18W LED 3000k 2020lm Illuminazione con sensore di presenza MCR	96,32 €
	EDRE18/WS/4000	EDGE R IP54 18W LED 4000K 2170lm Illuminazione con sensore di presenza MCR	96,32 €
	EDRE24/WH/3000	EDGE R IP54 24W LED 3000k 2405lm Illuminazione	81,94 €
	EDRE24/WH/4000	EDGE R IP54 24W LED 4000K 2585lm Illuminazione	81,94 €
	EDRE24/WS/3000	EDGE R IP54 24W LED 3000k 2405lm Illuminazione con sensore di presenza MCR	107,82 €
	EDRE24/WS/4000	EDGE R IP54 24W LED 4000K 2585lm Illuminazione con sensore di presenza MCR	107,82 €
STANDARD	EDRE12/1W/E/1/SE/X/WH/3000	EDGE R IP54 12W LED 3000K 1295lm Illuminazione + 1W LED 6500K 105lm STANDARD SE 1h	93,44 €
	EDRE12/1W/E/1/SE/X/WH/4000	EDGE R IP54 12W LED 4000K 1390lm Illuminazione + 1W LED 6500K 105lm STANDARD SE 1h	93,44 €
	EDRE12/1W/E/1/SE/X/WS/3000	EDGE R IP54 12W LED 3000K 1295lm Illuminazione + 1W LED 6500K 105lm STANDARD SE 1h, con sensore di presenza MCR	119,32 €
	EDRE12/1W/E/1/SE/X/WS/4000	EDGE R IP54 12W LED 4000K 1390lm Illuminazione + 1W LED 6500K 105lm STANDARD SE 1h, con sensore di presenza MCR	119,32 €
	EDRE12/1W/E/3/SE/X/WH/3000	EDGE R IP54 12W LED 3000K 1295lm Illuminazione + 1W LED 6500K 105lm STANDARD SE 3h	96,32 €
	EDRE12/1W/E/3/SE/X/WH/4000	EDGE R IP54 12W LED 4000K 1390lm Illuminazione + 1W LED 6500K 105lm STANDARD SE 3h	96,32 €
	EDRE12/1W/E/3/SE/X/WS/3000	EDGE R IP54 12W LED 3000K 1295lm Illuminazione + 1W LED 6500K 105lm STANDARD SE 3h con sensore di presenza MCR	122,20 €
	EDRE12/1W/E/3/SE/X/WS/4000	EDGE R IP54 12W LED 4000K 1390lm Illuminazione + 1W LED 6500K 105lm STANDARD SE 3h con sensore di presenza MCR	122,20 €
	EDRE18/1W/E/1/SE/X/WH/3000	EDGE R IP54 18W LED 3000k 2020lm Illuminazione + 1W LED 6500K 105lm STANDARD SE 1h	104,95 €
	EDRE18/1W/E/1/SE/X/WH/4000	EDGE R IP54 18W LED 4000K 2170lm Illuminazione + 1W LED 6500K 105lm STANDARD SE 1h	104,95 €
	EDRE18/1W/E/1/SE/X/WS/3000	EDGE R IP54 18W LED 3000k 2020lm Illuminazione + 1W LED 6500K 105lm STANDARD SE 1h, con sensore di presenza MCR	130,82 €
	EDRE18/1W/E/1/SE/X/WS/4000	EDGE R IP54 18W LED 4000K 2170lm Illuminazione + 1W LED 6500K 105lm STANDARD SE 1h, con sensore di presenza MCR	130,82 €
	EDRE18/1W/E/3/SE/X/WH/3000	EDGE R IP54 18W LED 3000k 2020lm Illuminazione + 1W LED 6500K 105lm STANDARD SE 3h	107,82 €
	EDRE18/1W/E/3/SE/X/WH/4000	EDGE R IP54 18W LED 4000K 2170lm Illuminazione + 1W LED 6500K 105lm STANDARD SE 3h	107,82 €
	EDRE18/1W/E/3/SE/X/WS/3000	EDGE R IP54 18W LED 3000k 2020lm Illuminazione + 1W LED 6500K 105lm STANDARD SE 3h con sensore di presenza MCR	133,70 €
	EDRE18/1W/E/3/SE/X/WS/4000	EDGE R IP54 18W LED 4000K 2170lm Illuminazione + 1W LED 6500K 105lm STANDARD SE 3h con sensore di presenza MCR	133,70 €
	EDRE24/1W/E/1/SE/X/WS/4000	EDGE R IP54 24W LED 4000K 2585lm Illuminazione + 1W LED 6500K 105lm STANDARD SE 1h, con sensore di presenza MCR	142,32 €
	EDRE24/1W/E/1/SE/X/WH/3000	EDGE R IP54 24W LED 3000k 2405lm Illuminazione + 1W LED 6500K 105lm STANDARD SE 1h	116,45 €
	EDRE24/1W/E/1/SE/X/WH/4000	EDGE R IP54 24W LED 4000K 2585lm Illuminazione + 1W LED 6500K 105lm STANDARD SE 1h	116,45 €
	EDRE24/1W/E/1/SE/X/WS/3000	EDGE R IP54 24W LED 3000k 2405lm Illuminazione + 1W LED 6500K 105lm STANDARD SE 1h, con sensore di presenza MCR	142,32 €
	EDRE24/1W/E/3/SE/X/WS/4000	EDGE R IP54 24W LED 4000K 2585lm Illuminazione + 1W LED 6500K 105lm STANDARD SE 3h con sensore di presenza MCR	145,20 €
	EDRE24/1W/E/3/SE/X/WH/3000	EDGE R IP54 24W LED 3000k 2405lm Illuminazione + 1W LED 6500K 105lm STANDARD SE 3h	119,32 €
	EDRE24/1W/E/3/SE/X/WH/4000	EDGE R IP54 24W LED 4000K 2585lm Illuminazione + 1W LED 6500K 105lm STANDARD SE 3h	119,32 €
	EDRE24/1W/E/3/SE/X/WS/3000	EDGE R IP54 24W LED 3000k 2405lm Illuminazione + 1W LED 6500K 105lm STANDARD SE 3h con sensore di presenza MCR	145,20 €

	CODICE ORDINE	EDGE ROUND	LISTINO
		IP54	
PREMIUM CON AUTOTEST	EDRE12/3W/B/1/SA/AT/WH/3000	EDGE R IP54 12W LED 3000K 1295lm Illuminazione + 3W LED 6500K 305lm PREMIUM SE 1h, con AUTOTEST	122,20 €
	EDRE12/3W/B/1/SA/AT/WH/4000	EDGE R IP54 12W LED 4000K 1390lm Illuminazione + 3W LED 6500K 305lm PREMIUM SE 1h, con AUTOTEST	122,20 €
	EDRE12/3W/B/1/SA/AT/WS/3000	EDGE R IP54 12W LED 3000K 1295lm Illuminazione + 3W LED 6500K 305lm PREMIUM SE 1h, con AUTOTEST con sensore di presenza MCR	148,07 €
	EDRE12/3W/B/1/SA/AT/WS/4000	EDGE R IP54 12W LED 4000K 1390lm Illuminazione + 3W LED 6500K 305lm PREMIUM SE 1h, con AUTOTEST con sensore di presenza MCR	148,07 €
	EDRE12/3W/B/3/SA/AT/WH/3000	EDGE R IP54 12W LED 3000K 1295lm Illuminazione + 3W LED 6500K 305lm PREMIUM SE 3h, con AUTOTEST	133,70 €
	EDRE12/3W/B/3/SA/AT/WH/4000	EDGE R IP54 12W LED 4000K 1390lm Illuminazione + 3W LED 6500K 305lm PREMIUM SE 3h, con AUTOTEST	133,70 €
	EDRE12/3W/B/3/SA/AT/WS/3000	EDGE R IP54 12W LED 3000K 1295lm Illuminazione + 3W LED 6500K 305lm PREMIUM SE 3h, con AUTOTEST con sensore di presenza MCR	159,58 €
	EDRE12/3W/B/3/SA/AT/WS/4000	EDGE R IP54 12W LED 4000K 1390lm Illuminazione + 3W LED 6500K 305lm PREMIUM SE 3h, con AUTOTEST con sensore di presenza MCR	159,58 €
	EDRE18/3W/B/1/SA/AT/WH/3000	EDGE R IP54 18W LED 3000k 2020lm Illuminazione + 3W LED 6500K 305lm PREMIUM SE 1h, con AUTOTEST	133,70 €
	EDRE18/3W/B/1/SA/AT/WH/4000	EDGE R IP54 18W LED 4000K 2170lm Illuminazione + 3W LED 6500K 305lm PREMIUM SE 1h, con AUTOTEST	133,70 €
	EDRE18/3W/B/1/SA/AT/WS/3000	EDGE R IP54 18W LED 3000k 2020lm Illuminazione + 3W LED 6500K 305lm PREMIUM SE 1h, con AUTOTEST con sensore di presenza MCR	159,58 €
	EDRE18/3W/B/1/SA/AT/WS/4000	EDGE R IP54 18W LED 4000K 2170lm Illuminazione + 3W LED 6500K 305lm PREMIUM SE 1h, con AUTOTEST con sensore di presenza MCR	159,58 €
	EDRE18/3W/B/3/SA/AT/WH/3000	EDGE R IP54 18W LED 3000k 2020lm Illuminazione + 3W LED 6500K 305lm PREMIUM SE 3h, con AUTOTEST	145,20 €
	EDRE18/3W/B/3/SA/AT/WH/4000	EDGE R IP54 18W LED 4000K 2170lm Illuminazione + 3W LED 6500K 305lm PREMIUM SE 3h, con AUTOTEST	145,20 €
	EDRE18/3W/B/3/SA/AT/WS/3000	EDGE R IP54 18W LED 3000k 2020lm Illuminazione + 3W LED 6500K 305lm PREMIUM SE 3h, con AUTOTEST con sensore di presenza MCR	171,08 €
	EDRE18/3W/B/3/SA/AT/WS/4000	EDGE R IP54 18W LED 4000K 2170lm Illuminazione + 3W LED 6500K 305lm PREMIUM SE 3h, con AUTOTEST con sensore di presenza MCR	171,08 €
	EDRE24/3W/B/1/SA/AT/WH/3000	EDGE R IP54 24W LED 3000k 2405lm Illuminazione + 3W LED 6500K 305lm PREMIUM SE 1h, con AUTOTEST	145,20 €
	EDRE24/3W/B/1/SA/AT/WH/4000	EDGE R IP54 24W LED 4000K 2585lm Illuminazione + 3W LED 6500K 305lm PREMIUM SE 1h, con AUTOTEST	145,20 €
	EDRE24/3W/B/1/SA/AT/WS/3000	EDGE R IP54 24W LED 3000k 2405lm Illuminazione + 3W LED 6500K 305lm PREMIUM SE 1h, con AUTOTEST con sensore di presenza MCR	171,08 €
	EDRE24/3W/B/1/SA/AT/WS/4000	EDGE R IP54 24W LED 4000K 2585lm Illuminazione + 3W LED 6500K 305lm PREMIUM SE 1h, con AUTOTEST con sensore di presenza MCR	171,08 €
EDRE24/3W/B/3/SA/AT/WH/3000	EDGE R IP54 24W LED 3000k 2405lm Illuminazione + 3W LED 6500K 305lm PREMIUM SE 3h, con AUTOTEST	156,70 €	
EDRE24/3W/B/3/SA/AT/WH/4000	EDGE R IP54 24W LED 4000K 2585lm Illuminazione + 3W LED 6500K 305lm PREMIUM SE 3h, con AUTOTEST	156,70 €	
EDRE24/3W/B/3/SA/AT/WS/3000	EDGE R IP54 24W LED 3000k 2405lm Illuminazione + 3W LED 6500K 305lm PREMIUM SE 3h, con AUTOTEST con sensore di presenza MCR	182,58 €	
EDRE24/3W/B/3/SA/AT/WS/4000	EDGE R IP54 24W LED 4000K 2585lm Illuminazione + 3W LED 6500K 305lm PREMIUM SE 3h, con AUTOTEST con sensore di presenza MCR	182,58 €	
CENTRAL BATTERY	EDRE12/12W/X/CB/X/WH/3000	EDGE R IP54 12W LED 3000K 1295lm Illuminazione per central battery system	64,84 €
	EDRE12/12W/X/CB/X/WH/4000	EDGE R IP54 12W LED 4000K 1390lm Illuminazione per central battery system	64,84 €
	EDRE18/18W/X/CB/X/WH/3000	EDGE R IP54 18W LED 3000k 2020lm Illuminazione per central battery system	77,49 €
	EDRE18/18W/X/CB/X/WH/4000	EDGE R IP54 18W LED 4000K 2170lm Illuminazione per central battery system	77,49 €
	EDRE24/24W/X/CB/X/WH/3000	EDGE R IP54 24W LED 3000k 2405lm Illuminazione per central battery system	90,15 €
	EDRE24/24W/X/CB/X/WH/4000	EDGE R IP54 24W LED 4000K 2585lm Illuminazione per central battery system	90,15 €

LEGGENDA:

SE	Emergenza	E	Apparecchio autonomo con elettronica tipo STANDARD
SA	Emergenza + SA	C	Apparecchio autonomo con elettronica tipo STANDARD
AT	autotest	B	Apparecchio autonomo con elettronica tipo PREMIUM
CB	central battery	F	Apparecchio NON AUTONOMO - Alimentazione centralizzata

EDGE S



AC
220-240V
50-60Hz

DC
176-275V

DC
24V

DC
48V

LED

IP54

IK08



MATERIALI

Corpo Bianco in policarbonato • Cover in policarbonato opale

MONTAGGIO

Superficie • Opzione incasso ⁽¹⁾

ALIMENTAZIONE

Autonoma – 220 - 240VAC/50 - 60Hz
Central battery – 220 - 240VAC/50 - 60Hz; 176 - 275VDC
Central battery FZLV II – 48VDC *
Central battery FZLV – 24VDC *

SORGENTE LUMINOSA - MAINS MODE

Power: 12W, 18W, 24W LED
Temperatura colore: 3000K, 4000K, 6000K

SORGENTE LUMINOSA - EMERGENCY MODE

Power: 1W, 3W LED
Temperatura colore: 6500K

RICARICA

Standard: max. 24h
Premium: max. 12h; charger a risparmio energetico

AUTONOMIA E BATTERIE

Standard: 1h o 3h, Ni-Cd 3,6V batteria
Premium: 1h o 3h, LiFePO₄ 6,4V batteria

CLASSE

II

GRADO IP & IK

IP54, IK08

TEMPERATURA

Autonoma: t_a: 0°C ÷ 40°C • t_a: -25°C ÷ 40°C – together with heater for low temperatures
Central battery: t_a: 0°C ÷ 50°C

OPZIONI

SE – Solo emergenza • SA – sempre accesa • AT – autotest • PT – pulsante di test
• CB – central battery • Versioni central test RUBIC o alimentazione e controllo centralizzato *

INFORMAZIONI

LED indicazione stato alimentazione e ricarica batteria • Protezione contro scarica profonda
• Optional apparecchio con sensore di presenza MCR • Opzione con adattatore per la gestione alla basse temperature fino a -25°C con HTR 25 • ⁽¹⁾ vedi accessori per montaggio a incasso

* su richiesta

DIMENSIONI [mm]

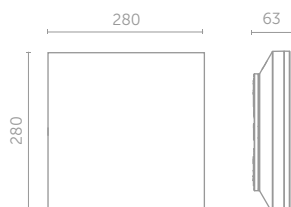

	CODICE ORDINE	EDGE SQUARE	LISTINO
		IP54	
ILLUMINAZIONE	EDSE12/WH/3000	EDGE S IP54 12W LED 3000K 1460lm Illuminazione	54,63 €
	EDSE12/WH/4000	EDGE S IP54 12W LED 4000K 1425lm Illuminazione	54,63 €
	EDSE12/WS/3000	EDGE S IP54 12W LED 3000K 1460lm Illuminazione con sensore di presenza MCR	80,51 €
	EDSE12/WS/4000	EDGE S IP54 12W LED 4000K 1425lm Illuminazione con sensore di presenza MCR	80,51 €
	EDSE18/WH/3000	EDGE S IP54 18W LED 3000k 2080lm Illuminazione	66,13 €
	EDSE18/WH/4000	EDGE S IP54 18W LED 4000K 2235lm Illuminazione	66,13 €
	EDSE18/WS/3000	EDGE S IP54 18W LED 3000k 2080lm Illuminazione con sensore di presenza MCR	92,01 €
	EDSE18/WS/4000	EDGE S IP54 18W LED 4000K 2235lm Illuminazione con sensore di presenza MCR	92,01 €
	EDSE24/WH/3000	EDGE S IP54 24W LED 3000k 2500lm Illuminazione	77,63 €
	EDSE24/WH/4000	EDGE S IP54 24W LED 4000K 2690lm Illuminazione	77,63 €
	EDSE24/WS/3000	EDGE S IP54 24W LED 3000k 2500lm Illuminazione con sensore di presenza MCR	103,51 €
	EDSE24/WS/4000	EDGE S IP54 24W LED 4000K 2690lm Illuminazione con sensore di presenza MCR	103,51 €
STANDARD	EDSE12/1W/E/1/SE/X/WH/3000	EDGE S IP54 12W LED 3000K 1460lm Illuminazione + 1W LED 6500K 105lm STANDARD SE 1h	89,13 €
	EDSE12/1W/E/1/SE/X/WH/4000	EDGE S IP54 12W LED 4000K 1425lm Illuminazione + 1W LED 6500K 105lm STANDARD SE 1h	89,13 €
	EDSE12/1W/E/1/SE/X/WS/3000	EDGE S IP54 12W LED 3000K 1460lm Illuminazione + 1W LED 6500K 105lm STANDARD SE 1h, con sensore di presenza MCR	115,01 €
	EDSE12/1W/E/1/SE/X/WS/4000	EDGE S IP54 12W LED 4000K 1425lm Illuminazione + 1W LED 6500K 105lm STANDARD SE 1h, con sensore di presenza MCR	115,01 €
	EDSE12/1W/E/3/SE/X/WH/3000	EDGE S IP54 12W LED 3000K 1460lm Illuminazione + 1W LED 6500K 105lm STANDARD SE 3h	92,01 €
	EDSE12/1W/E/3/SE/X/WH/4000	EDGE S IP54 12W LED 4000K 1425lm Illuminazione + 1W LED 6500K 105lm STANDARD SE 3h	92,01 €
	EDSE12/1W/E/3/SE/X/WS/3000	EDGE S IP54 12W LED 3000K 1460lm Illuminazione + 1W LED 6500K 105lm STANDARD SE 3h con sensore di presenza MCR	117,88 €
	EDSE12/1W/E/3/SE/X/WS/4000	EDGE S IP54 12W LED 4000K 1425lm Illuminazione + 1W LED 6500K 105lm STANDARD SE 3h con sensore di presenza MCR	117,88 €
	EDSE18/1W/E/1/SE/X/WH/3000	EDGE S IP54 18W LED 3000k 2080lm Illuminazione + 1W LED 6500K 105lm STANDARD SE 1h	100,63 €
	EDSE18/1W/E/1/SE/X/WH/4000	EDGE S IP54 18W LED 4000K 2235lm Illuminazione + 1W LED 6500K 105lm STANDARD SE 1h	100,63 €
	EDSE18/1W/E/1/SE/X/WS/3000	EDGE S IP54 18W LED 3000k 2080lm Illuminazione + 1W LED 6500K 105lm STANDARD SE 1h, con sensore di presenza MCR	126,51 €
	EDSE18/1W/E/1/SE/X/WS/4000	EDGE S IP54 18W LED 4000K 2235lm Illuminazione + 1W LED 6500K 105lm STANDARD SE 1h, con sensore di presenza MCR	126,51 €
	EDSE18/1W/E/3/SE/X/WH/3000	EDGE S IP54 18W LED 3000k 2080lm Illuminazione + 1W LED 6500K 105lm STANDARD SE 3h	103,51 €
	EDSE18/1W/E/3/SE/X/WH/4000	EDGE S IP54 18W LED 4000K 2235lm Illuminazione + 1W LED 6500K 105lm STANDARD SE 3h	103,51 €
	EDSE18/1W/E/3/SE/X/WS/3000	EDGE S IP54 18W LED 3000k 2080lm Illuminazione + 1W LED 6500K 105lm STANDARD SE 3h con sensore di presenza MCR	129,39 €
	EDSE18/1W/E/3/SE/X/WS/4000	EDGE S IP54 18W LED 4000K 2235lm Illuminazione + 1W LED 6500K 105lm STANDARD SE 3h con sensore di presenza MCR	129,39 €
	EDSE24/1W/E/1/SE/X/WH/3000	EDGE S IP54 24W LED 3000k 2500lm Illuminazione + 1W LED 6500K 105lm STANDARD SE 1h	112,13 €
	EDSE24/1W/E/1/SE/X/WH/4000	EDGE S IP54 24W LED 4000K 2690lm Illuminazione + 1W LED 6500K 105lm STANDARD SE 1h	112,13 €
	EDSE24/1W/E/1/SE/X/WS/3000	EDGE S IP54 24W LED 3000k 2500lm Illuminazione + 1W LED 6500K 105lm STANDARD SE 1h, con sensore di presenza MCR	138,01 €
	EDSE24/1W/E/1/SE/X/WS/4000	EDGE S IP54 24W LED 4000K 2690lm Illuminazione + 1W LED 6500K 105lm STANDARD SE 1h, con sensore di presenza MCR	138,01 €
	EDSE24/1W/E/3/SE/X/WH/3000	EDGE S IP54 24W LED 3000k 2500lm Illuminazione + 1W LED 6500K 105lm STANDARD SE 3h	115,01 €
	EDSE24/1W/E/3/SE/X/WH/4000	EDGE S IP54 24W LED 4000K 2690lm Illuminazione + 1W LED 6500K 105lm STANDARD SE 3h	115,01 €
	EDSE24/1W/E/3/SE/X/WS/3000	EDGE S IP54 24W LED 3000k 2500lm Illuminazione + 1W LED 6500K 105lm STANDARD SE 3h con sensore di presenza MCR	140,89 €
	EDSE24/1W/E/3/SE/X/WS/4000	EDGE S IP54 24W LED 4000K 2690lm Illuminazione + 1W LED 6500K 105lm STANDARD SE 3h con sensore di presenza MCR	140,89 €

	CODICE ORDINE	EDGE SQUARE	LISTINO
		IP54	
PREMIUM CON AUTOTEST	EDSE12/3W/B/1/SA/AT/WH/3000	EDGE S IP54 12W LED 3000K 1460lm Illuminazione + 3W LED 6500K 315lm PREMIUM SE 1h, con AUTOTEST	117,88 €
	EDSE12/3W/B/1/SA/AT/WH/4000	EDGE S IP54 12W LED 4000K 1425lm Illuminazione + 3W LED 6500K 315lm PREMIUM SE 1h, con AUTOTEST	117,88 €
	EDSE12/3W/B/1/SA/AT/WS/3000	EDGE S IP54 12W LED 3000K 1460lm Illuminazione + 3W LED 6500K 315lm PREMIUM SE 1h, con AUTOTEST con sensore di presenza MCR	143,76 €
	EDSE12/3W/B/1/SA/AT/WS/4000	EDGE S IP54 12W LED 4000K 1425lm Illuminazione + 3W LED 6500K 315lm PREMIUM SE 1h, con AUTOTEST con sensore di presenza MCR	143,76 €
	EDSE12/3W/B/3/SA/AT/WH/3000	EDGE S IP54 12W LED 3000K 1460lm Illuminazione + 3W LED 6500K 315lm PREMIUM SE 3h, con AUTOTEST	129,39 €
	EDSE12/3W/B/3/SA/AT/WH/4000	EDGE S IP54 12W LED 4000K 1425lm Illuminazione + 3W LED 6500K 315lm PREMIUM SE 3h, con AUTOTEST	129,39 €
	EDSE12/3W/B/3/SA/AT/WS/3000	EDGE S IP54 12W LED 3000K 1460lm Illuminazione + 3W LED 6500K 315lm PREMIUM SE 3h, con AUTOTEST con sensore di presenza MCR	155,26 €
	EDSE12/3W/B/3/SA/AT/WS/4000	EDGE S IP54 12W LED 4000K 1425lm Illuminazione + 3W LED 6500K 315lm PREMIUM SE 3h, con AUTOTEST con sensore di presenza MCR	155,26 €
	EDSE18/3W/B/1/SA/AT/WH/3000	EDGE S IP54 18W LED 3000k 2080lm Illuminazione + 3W LED 6500K 315lm PREMIUM SE 1h, con AUTOTEST	129,39 €
	EDSE18/3W/B/1/SA/AT/WH/4000	EDGE S IP54 18W LED 4000K 2235lm Illuminazione + 3W LED 6500K 315lm PREMIUM SE 1h, con AUTOTEST	129,39 €
	EDSE18/3W/B/1/SA/AT/WS/3000	EDGE S IP54 18W LED 3000k 2080lm Illuminazione + 3W LED 6500K 315lm PREMIUM SE 1h, con AUTOTEST con sensore di presenza MCR	155,26 €
	EDSE18/3W/B/1/SA/AT/WS/4000	EDGE S IP54 18W LED 4000K 2235lm Illuminazione + 3W LED 6500K 315lm PREMIUM SE 1h, con AUTOTEST con sensore di presenza MCR	155,26 €
	EDSE18/3W/B/3/SA/AT/WH/3000	EDGE S IP54 18W LED 3000k 2080lm Illuminazione + 3W LED 6500K 315lm PREMIUM SE 3h, con AUTOTEST	140,89 €
	EDSE18/3W/B/3/SA/AT/WH/4000	EDGE S IP54 18W LED 4000K 2235lm Illuminazione + 3W LED 6500K 315lm PREMIUM SE 3h, con AUTOTEST	140,89 €
	EDSE18/3W/B/3/SA/AT/WS/3000	EDGE S IP54 18W LED 3000k 2080lm Illuminazione + 3W LED 6500K 315lm PREMIUM SE 3h, con AUTOTEST con sensore di presenza MCR	166,76 €
	EDSE18/3W/B/3/SA/AT/WS/4000	EDGE S IP54 18W LED 4000K 2235lm Illuminazione + 3W LED 6500K 315lm PREMIUM SE 3h, con AUTOTEST con sensore di presenza MCR	166,76 €
	EDSE24/3W/B/1/SA/AT/WH/3000	EDGE S IP54 24W LED 3000k 2500lm Illuminazione + 3W LED 6500K 315lm PREMIUM SE 1h, con AUTOTEST	140,89 €
	EDSE24/3W/B/1/SA/AT/WH/4000	EDGE S IP54 24W LED 4000K 2690lm Illuminazione + 3W LED 6500K 315lm PREMIUM SE 1h, con AUTOTEST	140,89 €
	EDSE24/3W/B/1/SA/AT/WS/3000	EDGE S IP54 24W LED 3000k 2500lm Illuminazione + 3W LED 6500K 315lm PREMIUM SE 1h, con AUTOTEST con sensore di presenza MCR	166,76 €
	EDSE24/3W/B/1/SA/AT/WS/4000	EDGE S IP54 24W LED 4000K 2690lm Illuminazione + 3W LED 6500K 315lm PREMIUM SE 1h, con AUTOTEST con sensore di presenza MCR	166,76 €
EDSE24/3W/B/3/SA/AT/WH/3000	EDGE S IP54 24W LED 3000k 2500lm Illuminazione + 3W LED 6500K 315lm PREMIUM SE 3h, con AUTOTEST	152,39 €	
EDSE24/3W/B/3/SA/AT/WH/4000	EDGE S IP54 24W LED 4000K 2690lm Illuminazione + 3W LED 6500K 315lm PREMIUM SE 3h, con AUTOTEST	152,39 €	
EDSE24/3W/B/3/SA/AT/WS/3000	EDGE S IP54 24W LED 3000k 2500lm Illuminazione + 3W LED 6500K 315lm PREMIUM SE 3h, con AUTOTEST con sensore di presenza MCR	178,26 €	
EDSE24/3W/B/3/SA/AT/WS/4000	EDGE S IP54 24W LED 4000K 2690lm Illuminazione + 3W LED 6500K 315lm PREMIUM SE 3h, con AUTOTEST con sensore di presenza MCR	178,26 €	
CENTRAL BATTERY	EDSE12/12W/X/CB/X/WH/3000	EDGE S IP54 12W LED 3000K 1460lm Illuminazione per central battery system	60,10 €
	EDSE12/12W/X/CB/X/WH/4000	EDGE S IP54 12W LED 4000K 1425lm Illuminazione per central battery system	60,10 €
	EDSE18/18W/X/CB/X/WH/3000	EDGE S IP54 18W LED 3000k 2080lm Illuminazione per central battery system	72,75 €
	EDSE18/18W/X/CB/X/WH/4000	EDGE S IP54 18W LED 4000K 2235lm Illuminazione per central battery system	72,75 €
	EDSE24/24W/X/CB/X/WH/3000	EDGE S IP54 24W LED 3000k 2500lm Illuminazione per central battery system	85,40 €
	EDSE24/24W/X/CB/X/WH/4000	EDGE S IP54 24W LED 4000K 2690lm Illuminazione per central battery system	85,40 €

LEGGENDA:

SE	Emergenza	E	Apparecchio autonomo con elettronica tipo STANDARD
SA	Emergenza + SA	C	Apparecchio autonomo con elettronica tipo STANDARD
AT	autotest	B	Apparecchio autonomo con elettronica tipo PREMIUM
CB	central battery	F	Apparecchio NON AUTONOMO - Alimentazione centralizzata

EDGE accessori



**ACCESSORIO PER INCASSO NEL
CONTROSOFFITTO**

CODICE: EDSE/REC/WH

DIMENSIONI [mm]

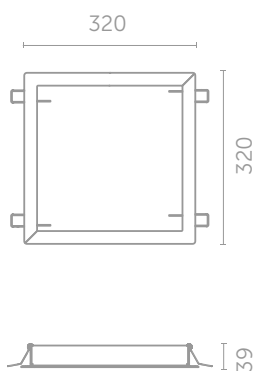

ADATTABILE A EDGE S



HELIOS LED



AC
220-240V
50-60Hz

DC
176-275V

DC
24V

DC
48V

LED

IP42

IP65

IK08

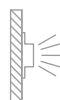

KM 618355
BS-EN 60598-2-22



MATERIALI

Corpo Bianco in policarbonato • Cover in policarbonato

MONTAGGI

Superficie

ALIMENTAZIONE

Autonoma – 220 - 240VAC/50 - 60Hz
Central battery – 220 - 240VAC/50 - 60Hz; 176 - 275VDC
Central battery FZLV II – 48VDC *
Central battery FZLV – 24VDC *

SORGENTE

1W, 2W, 3W, 4W, 3x1W, 6x1W LED
Colour temperature: 6000K
Lifetime: 50000h

RICARICA

Standard: max. 24h
Premium: max. 12h; charger a risparmio energetico

AUTONOMIA E BATTERIE

Standard: 1h o 3h, Ni-Cd 3,6V batteria
Premium: 1h o 3h, LiFePO₄ 6,4V batteria

CLASSE

II o III

GRADO IP & IK

IP42 o IP65, IK08

TEMPERATURA

Autonoma: t_a : 0°C ÷ 40°C • t_a : -25°C ÷ 40°C – con sistema per gestione alle basse temperature
Central battery: t_a : -25°C ÷ 50°C

OPZIONI

SE – solo emergenza • SA – sempre accesa • AT – autotest • PT – pulsante di test
• CB – central battery • Versioni central test RUBIC o alimentazione e controllo centralizzato *

INFORMAZIONI

LED indicazione stato alimentazione e ricarica batteria • Protezione contro scarica profonda
• Opzione con adattatore per la gestione alla basse temperature fino a -25°C with HTR 25
• Classe di isolamento III per versione FZLV e FZLV2

* su richiesta

DIMENSIONI [mm]



	CODICE ORDINE	HELIOS LED	LISTINO
		IP65	
STANDARD	HWD/3x1W/C/1/SE/X/TR	HELIOS HWD 3x1W LED 340 lm STANDARD IP65 1h autonomia, SE, plafoniera trasparente	106,89 €
	HWD/3x1W/C/3/SE/X/TR	HELIOS HWD 3x1W LED 340 lm STANDARD IP65 3h autonomia, SE, plafoniera trasparente	116,96 €
	HWD/3x1W/C/1/SA/X/TR	HELIOS HWD 3x1W LED 340 lm STANDARD IP65 1h autonomia, SE + SA plafoniera trasparente	109,19 €
	HWD/3x1W/C/3/SA/X/TR	HELIOS HWD 3x1W LED 340 lm STANDARD IP65 3h autonomia, SE + SA plafoniera trasparente	119,26 €
	HWED/3x1W/C/1/SE/X/TR	HELIOS HWD 3x1W LED 340 lm STANDARD IP42 1h autonomia, SE, plafoniera trasparente	105,74 €
	HWED/3x1W/C/3/SE/X/TR	HELIOS HWD 3x1W LED 340 lm STANDARD IP42 3h autonomia, SE, plafoniera trasparente	115,81 €
	HWED/3x1W/C/1/SA/X/TR	HELIOS HWD 3x1W LED 340 lm STANDARD IP42 1h autonomia, SE + SA plafoniera trasparente	108,04 €
	HWED/3x1W/C/3/SA/X/TR	HELIOS HWD 3x1W LED 340 lm STANDARD IP42 3h autonomia, SE + SA plafoniera trasparente	118,11 €
	HWEM/3W/C/1/SE/X/TR	HELIOS HWM 3W LED 410 lm STANDARD IP42 1h autonomia, SE, plafoniera trasparente	77,14 €
	HWEM/3W/C/3/SE/X/TR	HELIOS HWM 3W LED 410 lm STANDARD IP42 3h autonomia, SE, plafoniera trasparente	92,83 €
	HWEM/3W/C/1/SA/X/TR	HELIOS HWM 3W LED 410 lm STANDARD IP42 1h autonomia, SE + SA plafoniera trasparente	79,44 €
	HWEM/3W/C/3/SA/X/TR	HELIOS HWM 3W LED 410 lm STANDARD IP42 3h autonomia, SE + SA plafoniera trasparente	95,14 €
	HWM/3W/C/1/SE/X/TR	HELIOS HWM 3W LED 410 lm STANDARD IP65 1h autonomia, SE, plafoniera trasparente	84,48 €
	HWM/3W/C/3/SE/X/TR	HELIOS HWM 3W LED 410 lm STANDARD IP65 3h autonomia, SE, plafoniera trasparente	100,05 €
	HWM/3W/C/1/SA/X/TR	HELIOS HWM 3W LED 410 lm STANDARD IP65 1h autonomia, SE + SA plafoniera trasparente	86,63 €
	HWM/3W/C/3/SA/X/TR	HELIOS HWM 3W LED 410 lm STANDARD IP65 3h autonomia, SE + SA plafoniera trasparente	102,35 €
PREMIUM CON AUTOTEST	HWD/3x1W/B/1/SE/AT/TR	HELIOS HWD 3x1W LED 460 lm PREMIUM IP65 1h autonomia, SE, con AUTOTEST plafoniera trasparente	114,08 €
	HWD/3x1W/B/3/SE/AT/TR	HELIOS HWD 3x1W LED 460 lm PREMIUM IP65 3h autonomia, SE, con AUTOTEST plafoniera trasparente	124,14 €
	HWD/3x1W/B/1/SA/AT/TR	HELIOS HWD 3x1W LED 460 lm PREMIUM IP65 1h autonomia, SE + SA, con AUTOTEST plafoniera trasparente	118,88 €
	HWD/3x1W/B/3/SA/AT/TR	HELIOS HWD 3x1W LED 460 lm PREMIUM IP65 3h autonomia, SE + SA, con AUTOTEST plafoniera trasparente	126,44 €
	HWED/3x1W/B/1/SE/AT/TR	HELIOS HWD 3x1W LED 460 lm PREMIUM IP42 1h autonomia, SE, con AUTOTEST plafoniera trasparente	112,96 €
	HWED/3x1W/B/3/SE/AT/TR	HELIOS HWD 3x1W LED 460 lm PREMIUM IP42 3h autonomia, SE, con AUTOTEST plafoniera trasparente	122,99 €
	HWED/3x1W/B/1/SA/AT/TR	HELIOS HWD 3x1W LED 460 lm PREMIUM IP42 1h autonomia, SE + SA, con AUTOTEST plafoniera trasparente	115,26 €
	HWED/3x1W/B/3/SA/AT/TR	HELIOS HWD 3x1W LED 460 lm PREMIUM IP42 3h autonomia, SE + SA, con AUTOTEST plafoniera trasparente	125,29 €
	HWEM/3W/B/1/SE/AT/TR	HELIOS HWM 3W LED 460 lm PREMIUM IP42 1h autonomia, SE, con AUTOTEST plafoniera trasparente	84,48 €
	HWEM/3W/B/3/SE/AT/TR	HELIOS HWM 3W LED 460 lm PREMIUM IP42 3h autonomia, SE, con AUTOTEST plafoniera trasparente	100,02 €
	HWEM/3W/B/1/SA/AT/TR	HELIOS HWM 3W LED 460 lm PREMIUM IP42 1h autonomia, SE + SA, con AUTOTEST plafoniera trasparente	86,63 €
	HWEM/3W/B/3/SA/AT/TR	HELIOS HWM 3W LED 460 lm PREMIUM IP42 3h autonomia, SE + SA, con AUTOTEST plafoniera trasparente	102,33 €
	HWM/3W/B/1/SE/AT/TR	HELIOS HWM 3W LED 460 lm PREMIUM IP65 1h autonomia, SE, con AUTOTEST plafoniera trasparente	91,51 €
	HWM/3W/B/3/SE/AT/TR	HELIOS HWM 3W LED 460 lm PREMIUM IP65 3h autonomia, SE, con AUTOTEST plafoniera trasparente	107,24 €
	HWM/3W/B/1/SA/AT/TR	HELIOS HWM 3W LED 460 lm PREMIUM IP65 1h autonomia, SE + SA, con AUTOTEST plafoniera trasparente	93,82 €
	HWM/3W/B/3/SA/AT/TR	HELIOS HWM 3W LED 460 lm PREMIUM IP65 3h autonomia, SE + SA, con AUTOTEST plafoniera trasparente	109,54 €
	HHP/6x1W/B/1/SE/AT/TR	HELIOS HHP 6x1W LED 920 lm PREMIUM IP65 1h autonomia, solo Emergenza, con AUTOTEST plafoniera trasparente	134,97 €
	HHP/6x1W/B/3/SE/AT/TR	HELIOS HHP 6x1W LED 920 lm PREMIUM IP65 3h autonomia, solo Emergenza, con AUTOTEST plafoniera trasparente	183,46 €
HHP/6x1W/B/1/SA/AT/TR	HELIOS HHP 6x1W LED 920 lm PREMIUM IP65 1h autonomia, SE + SA, con AUTOTEST plafoniera trasparente	137,28 €	
HHP/6x1W/B/3/SA/AT/TR	HELIOS HHP 6x1W LED 920 lm PREMIUM IP65 3h autonomia, SE + SA, con AUTOTEST plafoniera trasparente	185,76 €	

	CODICE ORDINE	HELIOS LED		LISTINO
		IP65		
CENTRAL BATTERY	HWD/3x1W/F/CB/X/TR	HELIOS HWD 3x1W LED 460 lm IP65 per central battery system plafoniera trasparente		114,08 €
	HWED/3x1W/F/CB/X/TR	HELIOS HWD 3x1W LED 460 lm IP42 per central battery system plafoniera trasparente		112,96 €
	HWEM/3W/F/CB/X/TR	HELIOS HWM 3W LED 460 lm IP42 per central battery system plafoniera trasparente		84,48 €
	HWM/3W/F/CB/X/TR	HELIOS HWM 3W LED 460 lm IP65 per central battery system plafoniera trasparente		91,51 €
	HHP/6x1W/F/CB/X/TR	HELIOS HHP 6x1W LED 920 lm IP65 per central battery system plafoniera trasparente		134,96 €

LEGGENDA:

SE	Emergenza	E	Apparecchio autonomo con elettronica tipo STANDARD
SA	Emergenza + SA	C	Apparecchio autonomo con elettronica tipo STANDARD
AT	autotest	B	Apparecchio autonomo con elettronica tipo PREMIUM
CB	central battery	F	Apparecchio NON AUTONOMO - Alimentazione centralizzata



HELIOS LED

AC
220-240V
50-60Hz

DC
176-275V

DC
24V

DC
48V

LED

IP42

IP65

IK08

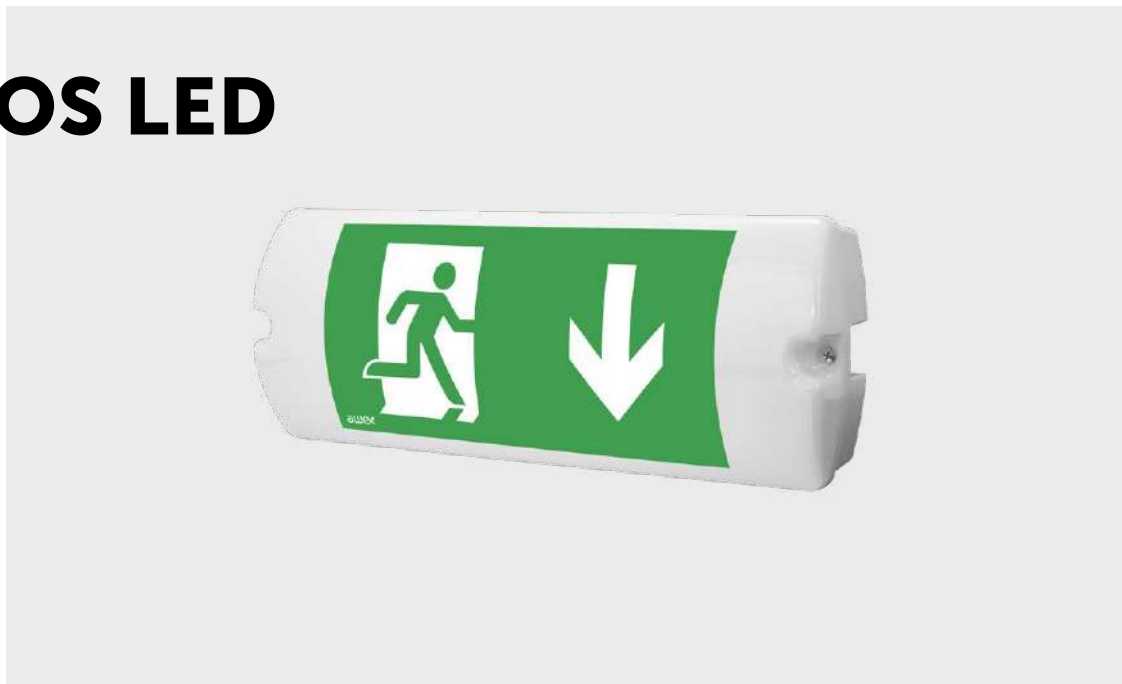

KM 618355
BS-EN 60598-2-22



MATERIALI

Corpo Bianco in policarbonato • Cover in policarbonato opale

MONTAGGI

Superficie • Installazione a parete o soffitto (opzione con staffa per soffitto) ⁽¹⁾

ALIMENTAZIONE

Autonoma – 220 - 240VAC/50 - 60Hz
Central battery – 220 - 240VAC/50 - 60Hz; 176 - 275VDC
Central battery FZLV II – 48VDC *
Central battery FZLV – 24VDC *

SORGENTE

1W, 2W LED
Colour temperature: 6000K
Lifetime: 50000h

RICARICA

Standard: max. 24h
Premium: max. 12h; charger a risparmio energetico

AUTONOMIA E BATTERIE

Standard: 1h o 3h, Ni-Cd 3,6V batteria
Premium: 1h o 3h, LiFePO₄ 6,4V batteria

CLASSE

II o III

GRADO IP & IK

IP42 o IP65, IK08

DISTANZA DI VISIBILITA'

25 m

TIPOLOGIA

Singola faccia

TEMPERATURA

Autonoma: t_a: 0°C ÷ 40°C • t_b: -25°C ÷ 40°C – con sistema per gestione alle basse temperature
Central battery: t_b: -25°C ÷ 50°C

OPZIONI

SE – solo emergenza • SA – sempre accesa • AT – autotest • PT – pulsante di test
• CB – central battery • Versioni central test RUBIC o alimentazione e controllo centralizzato *

INFORMAZIONI

LED indicazione stato alimentazione e ricarica batteria • Protezione contro scarica profonda • Gestione delle basse temperature fino a -25°C con HTR 25 (opzionale) • Classe di isolamento III per versione FZLV e FZLV2 • ⁽¹⁾ guarda accessori • ⁽²⁾ 1pz di pittogramma universale è incluso in ogni confezione

* su richiesta

DIMENSIONI [mm]

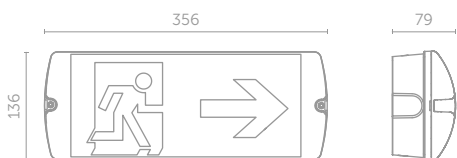

⁽²⁾ pittogramma

	CODICE ORDINE	HELIOS SEGNALAZIONE		LISTINO
		PARETE		
STANDARD	HL/1W/C/1/SA/X/OP	HELIOS LED 1W LED STANDARD IP65 1h autonomia, SE + SA plafoniera opale		63,39 €
	HL/1W/C/3/SA/X/OP	HELIOS LED 1W LED STANDARD IP65 3h autonomia, SE + SA plafoniera opale		66,21 €
	HL/2W/C/1/SA/X/OP	HELIOS LED 2W LED STANDARD IP65 1h autonomia, SE + SA plafoniera opale		70,58 €
	HL/2W/C/3/SA/X/OP	HELIOS LED 2W LED STANDARD IP65 3h autonomia, SE + SA plafoniera opale		74,84 €
PREMIUM CON AUTOTEST	HL/1W/B/1/SA/AT/OP	HELIOS LED 1W LED PREMIUM IP65 1h autonomia, SE + SA, con AUTOTEST plafoniera opale		77,77 €
	HL/1W/B/3/SA/AT/OP	HELIOS LED 1W LED PREMIUM IP65 3h autonomia, SE + SA, con AUTOTEST plafoniera opale		80,59 €
	HL/2W/B/1/SA/AT/OP	HELIOS LED 2W LED PREMIUM IP65 1h autonomia, SE + SA, con AUTOTEST plafoniera opale		84,96 €
	HL/2W/B/3/SA/AT/OP	HELIOS LED 2W LED PREMIUM IP65 3h autonomia, SE + SA, con AUTOTEST plafoniera opale		89,21 €
CENTRAL BATTERY	HL/1W/F/CB/X/OP	HELIOS LED 1W LED IP65 per central battery system plafoniera opale		77,77 €
	HL/2W/F/CB/X/OP	HELIOS LED 2W LED IP65 per central battery system plafoniera opale		84,96 €

LEGGENDA:

SE	Emergenza	E	Apparecchio autonomo con elettronica tipo STANDARD
SA	Emergenza + SA	C	Apparecchio autonomo con elettronica tipo STANDARD
AT	autotest	B	Apparecchio autonomo con elettronica tipo PREMIUM
CB	central battery	F	Apparecchio NON AUTONOMO - Alimentazione centralizzata



HELIOS DS LED

AC
220-240V
50-60Hz

DC
176-275V

DC
24V

DC
48V

LED

IP42

IP65

IK08



KM 618355
BS-EN 60598-2-22



MATERIALI

Corpo Bianco in policarbonato • Cover in policarbonato opale

MONTAGGI

Superficie • Installazione a parete o soffitto (opzione con staffa per soffitto) ⁽¹⁾

ALIMENTAZIONE

Autonoma – 220 - 240VAC/50 - 60Hz
Central battery – 220 - 240VAC/50 - 60Hz; 176 - 275VDC
Central battery FZLV II – 48VDC *
Central battery FZLV – 24VDC *

SORGENTE

1W, 2W LED
Colour temperature: 6000K
Lifetime: 50000h

RICARICA

Standard: max. 24h
Premium: max. 12h; charger a risparmio energetico

AUTONOMIA E BATTERIE

Standard: 1h o 3h, Ni-Cd 3,6V batteria
Premium: 1h o 3h, LiFePO₄ 6,4V batteria

CLASSE

II o III

GRADO IP & IK

IP42 o IP65, IK08

DISTANZA DI VISIBILITA'

25 m

TIPOLOGIA

Doppia faccia

TEMPERATURA

Autonoma: t_a: 0°C ÷ 40°C • t_s: -25°C ÷ 40°C – con sistema per gestione alle basse temperature
Central battery: t_s: -25°C ÷ 50°C

OPZIONI

SE – solo emergenza • SA – sempre accesa • AT – autotest • PT – pulsante di test
• CB – central battery • Versioni central test RUBIC o alimentazione e controllo centralizzato *

INFORMAZIONI

LED indicazione stato alimentazione e ricarica batteria • Protezione contro scarica profonda
• Gestione delle basse temperature fino a -25°C con HTR 25 (opzionale) • Classe di isolamento III per versione FZLV e FZLV2 • III class of insulation of FZLV and FZLV2 version
• ⁽¹⁾ vedi sezione accessori • ⁽²⁾ 1pz di pittogramma universale è incluso in ogni confezione

* su richiesta

DIMENSIONI [mm]

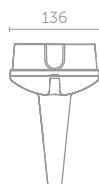

⁽²⁾ pittogramma

	CODICE ORDINE	HELIOS SEGNALAZIONE GRADO PROT.IP65		LISTINO
		SOFFITTO - DOUBLE SIDE		
STANDARD	HDL/1W/C/1/SA/X/OP	HELIOS DS LED 1W LED STANDARD IP65 1h autonomia, SE + SA plafoniera opale		72,01 €
	HDL/1W/C/3/SA/X/OP	HELIOS DS LED 1W LED STANDARD IP65 3h autonomia, SE + SA plafoniera opale		74,84 €
	HDL/2W/C/1/SA/X/OP	HELIOS DS LED 2W LED STANDARD IP65 1h autonomia, SE + SA plafoniera opale		79,21 €
	HDL/2W/C/3/SA/X/OP	HELIOS DS LED 2W LED STANDARD IP65 3h autonomia, SE + SA plafoniera opale		83,47 €
PREMIUM CON AUTOTEST	HDL/1W/B/1/SA/AT/OP	HELIOS DS LED 1W LED PREMIUM IP65 1h autonomia, SE + SA, con AUTOTEST plafoniera opale		86,40 €
	HDL/1W/B/3/SA/AT/OP	HELIOS DS LED 1W LED PREMIUM IP65 3h autonomia, SE + SA, con AUTOTEST plafoniera opale		89,22 €
	HDL/2W/B/1/SA/AT/OP	HELIOS DS LED 2W LED PREMIUM IP65 1h autonomia, SE + SA, con AUTOTEST plafoniera opale		93,47 €
	HDL/2W/B/3/SA/AT/OP	HELIOS DS LED 2W LED PREMIUM IP65 3h autonomia, SE + SA, con AUTOTEST plafoniera opale		97,84 €
CENTRAL BATTERY	HDL/1W/F/CB/X/OP	HELIOS LED DS 1W LED IP65 per central battery system plafoniera opale		86,40 €
	HDL/2W/F/CB/X/OP	HELIOS LED DS 2W LED IP65 per central battery system plafoniera opale		93,59 €

LEGGENDA:

SE	Emergenza	E	Apparecchio autonomo con elettronica tipo STANDARD
SA	Emergenza + SA	C	Apparecchio autonomo con elettronica tipo STANDARD
AT	autotest	B	Apparecchio autonomo con elettronica tipo PREMIUM
CB	central battery	F	Apparecchio NON AUTONOMO - Alimentazione centralizzata



HELIOS LED accessori



STAFFA A SOFFITTO

CODICE: 1902

DIMENSIONI [mm]

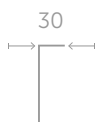
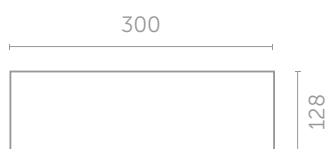

ADATTABILE A HELIOS LED



STAFFA A PARETE

CODICE: 1901

DIMENSIONI [mm]

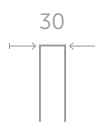
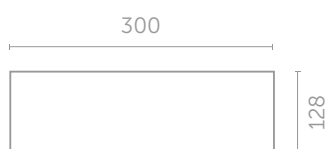

ADATTABILE A HELIOS LED



**STAFFA A SOFFITTO PER
INSTALLAZIONE A SOSPENSIONE**

CODICE: 2944

DIMENSIONI [mm]

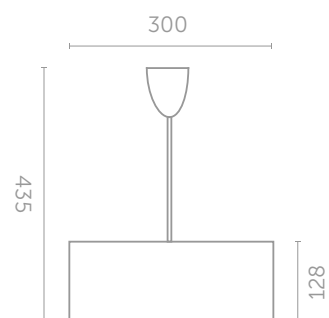

ADATTABILE A HELIOS LED



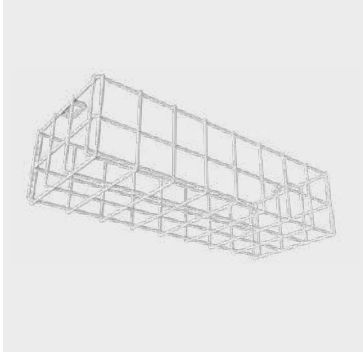

GRIGLIA DI PROTEZIONE

CODICE: 1003

DIMENSIONI [mm]

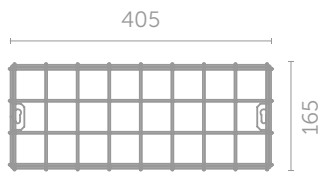

ADATTABILE A HELIOS LED



EXIT S

AC
220-240V
50-60Hz

DC
176-275V

DC
24V

DC
48V

LED

IP65

IK07

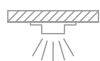

KM 618355
BS-EN 60598-2-22



MATERIALI

Bianco, Grigio o Nero polycarbonate body • Cover in polycarbonato

MONTAGGI

Superficie • Opzione da incasso ⁽¹⁾ • Opzione kit a sospensione ⁽²⁾

ALIMENTAZIONE

Autonoma – 220 - 240VAC/50 - 60Hz
Central battery – 220 - 240VAC/50 - 60Hz; 176 - 275VDC
Central battery FZLV II – 48VDC *
Central battery FZLV – 24VDC *

SORGENTE

1W, 2W, 3W LED
Optics: U – universal • R – escape route

RICARICA

Standard: max. 24h
Premium: max. 12h; charger a risparmio energetico

AUTONOMIA E BATTERIE

Standard: 1h o 3h, Ni-Cd 3,6V batteria
Premium: 1h o 3h, LiFePO₄ 6,4V batteria

CLASSE

II o III

GRADO IP & IK

IP65, IK07

TEMPERATURA

Autonoma: t_a: 0°C ÷ 40°C • t_s: -25°C ÷ 40°C – con sistema per gestione alle basse temperature
Central battery: t_s: -25°C ÷ 50°C

OPZIONI

SE – solo emergenza • SA – sempre accesa • AT – autotest • PT – pulsante di test
• CB – central battery • Versioni central test RUBIC o alimentazione e controllo centralizzato *

INFORMAZIONI

LED indicazione stato alimentazione e ricarica batteria • Protezione contro scarica profonda
• Gestione delle basse temperature fino a -25°C con HTR 25 (opzionale) • Classe di isolamento III per versione FZLV e FZLV2 • ⁽¹⁾ Vedi kit per incasso nella sezione accessori
• ⁽²⁾ Vedi sezione accessori

* su richiesta

DIMENSIONI [mm]



	CODICE ORDINE	EXIT S	LISTINO
		IP65	
STANDARD	ETS/1W/C/1/SA/X/WH	EXIT S 1W LED 170 lm STANDARD IP65 1h autonomia, SE + SA, colore Bianco	41,54 €
	ETS/1W/C/3/SA/X/WH	EXIT S 1W LED 170 lm STANDARD IP65 3h autonomia, SE + SA, colore Bianco	44,56 €
	ETS/1W/E/1/SE/X/WH	EXIT S 1W LED 170 lm STANDARD IP65 1h autonomia, solo Emergenza, colore Bianco	33,49 €
	ETS/1W/C/3/SE/X/WH	EXIT S 1W LED 170 lm STANDARD IP65 3h autonomia, solo Emergenza, colore Bianco	35,51 €
	ETS/2W/E/1/SE/X/WH	EXIT S 2W LED 270 lm STANDARD IP65 1h autonomia, SE, colore Bianco	46,58 €
	ETS/2W/C/3/SE/X/WH	EXIT S 2W LED 270 lm STANDARD IP65 3h autonomia, SE, colore Bianco	50,60 €
	ETS/2W/C/1/SA/X/WH	EXIT S 2W LED 270 lm STANDARD IP65 1h autonomia, SE + SA, colore Bianco	48,88 €
	ETS/2W/C/3/SA/X/WH	EXIT S 2W LED 270 lm STANDARD IP65 3h autonomia, SE + SA, colore Bianco	52,90 €
	ETS/3W/E/1/SE/X/WH	EXIT S 3W LED 395 lm STANDARD IP65 1h autonomia, SE, colore Bianco	51,61 €
	ETS/3W/C/3/SE/X/WH	EXIT S 3W LED 395 lm STANDARD IP65 3h autonomia, SE, colore Bianco	63,68 €
	ETS/3W/C/1/SA/X/WH	EXIT S 3W LED 395 lm STANDARD IP65 1h autonomia, SE + SA, colore Bianco	53,90 €
	ETS/3W/C/3/SA/X/WH	EXIT S 3W LED 395 lm STANDARD IP65 3h autonomia, SE + SA, colore Bianco	67,14 €
	ETSR/1W/E/1/SE/X/WH	EXIT S con ottica per vie di fuga 1W LED 170 lm STANDARD IP65 1h autonomia, solo Emergenza, colore Bianco	56,93 €
	ETSR/1W/C/3/SE/X/WH	EXIT S con ottica per vie di fuga 1W LED 170 lm STANDARD IP65 3h autonomia, solo Emergenza, colore Bianco	60,10 €
	ETSR/1W/C/1/SA/X/WH	EXIT S con ottica per vie di fuga 1W LED 170 lm STANDARD IP65 1h autonomia, SE + SA, colore Bianco	68,44 €
	ETSR/1W/C/3/SA/X/WH	EXIT S con ottica per vie di fuga 1W LED 170 lm STANDARD IP65 3h autonomia, SE + SA, colore Bianco	71,89 €
	ETSR/2W/C/1/SE/X/WH	EXIT S con ottica per vie di fuga 2W LED 270 lm STANDARD IP65 1h autonomia, SE, colore Bianco	70,73 €
	ETSR/2W/C/3/SE/X/WH	EXIT S con ottica per vie di fuga 2W LED 270 lm STANDARD IP65 3h autonomia, SE, colore Bianco	76,48 €
	ETSR/2W/C/1/SA/X/WH	EXIT S con ottica per vie di fuga 2W LED 270 lm STANDARD IP65 1h autonomia, SE + SA, colore Bianco	73,04 €
	ETSR/2W/C/3/SA/X/WH	EXIT S con ottica per vie di fuga 2W LED 270 lm STANDARD IP65 3h autonomia, SE + SA, colore Bianco	79,93 €
	ETSU/1W/C/1/SA/X/WH	EXIT S con Ottica Universale 1W LED 170 lm STANDARD IP65 1h autonomia, SE + SA, colore Bianco	66,14 €
	ETSU/1W/C/3/SA/X/WH	EXIT S con Ottica Universale 1W LED 170 lm STANDARD IP65 3h autonomia, SE + SA, colore Bianco	69,58 €
	ETSU/1W/E/1/SE/X/WH	EXIT S con Ottica Universale 1W LED 170 lm STANDARD IP65 1h autonomia, solo Emergenza, colore Bianco	56,93 €
	ETSU/1W/C/3/SE/X/WH	EXIT S con Ottica Universale 1W LED 170 lm STANDARD IP65 3h autonomia, solo Emergenza, colore Bianco	60,10 €
	ETSU/2W/C/1/SE/X/WH	EXIT S con Ottica Universale 2W LED 305 lm STANDARD IP65 1h autonomia, SE, colore Bianco	70,73 €
	ETSU/2W/C/3/SE/X/WH	EXIT S con Ottica Universale 2W LED 305 lm STANDARD IP65 3h autonomia, SE, colore Bianco	76,48 €
ETSU/2W/C/1/SA/X/WH	EXIT S con Ottica Universale 2W LED 305 lm STANDARD IP65 1h autonomia, SE + SA, colore Bianco	73,04 €	
ETSU/2W/C/3/SA/X/WH	EXIT S con Ottica Universale 2W LED 305 lm STANDARD IP65 3h autonomia, SE + SA, colore Bianco	79,93 €	
PREMIUM CON AUTOTEST	ETS/1W/B/1/SE/AT/WH	EXIT S 1W LED 175 lm PREMIUM IP65 1h autonomia, SE, con AUTOTEST, colore Bianco	62,67 €
	ETS/1W/B/3/SE/AT/WH	EXIT S 1W LED 175 lm PREMIUM IP65 3h autonomia, SE, con AUTOTEST, colore Bianco	66,70 €
	ETS/1W/B/1/SA/AT/WH	EXIT S 1W LED 175 lm PREMIUM IP65 1h autonomia, SE + SA, con AUTOTEST, colore Bianco	64,98 €
	ETS/1W/B/3/SA/AT/WH	EXIT S 1W LED 175 lm PREMIUM IP65 3h autonomia, SE + SA, con AUTOTEST, colore Bianco	69,00 €
	ETS/2W/B/1/SE/AT/WH	EXIT S 2W LED 335 lm PREMIUM IP65 1h autonomia, SE, con AUTOTEST, colore Bianco	66,70 €
	ETS/2W/B/3/SE/AT/WH	EXIT S 2W LED 335 lm PREMIUM IP65 3h autonomia, SE, con AUTOTEST, colore Bianco	70,73 €
	ETS/2W/B/1/SA/AT/WH	EXIT S 2W LED 335 lm PREMIUM IP65 1h autonomia, SE + SA, con AUTOTEST, colore Bianco	69,00 €
	ETS/2W/B/3/SA/AT/WH	EXIT S 2W LED 335 lm PREMIUM IP65 3h autonomia, SE + SA, con AUTOTEST, colore Bianco	73,04 €
	ETS/3W/B/1/SE/AT/WH	EXIT S 3W LED 410 lm PREMIUM IP65 1h autonomia, SE, con AUTOTEST, colore Bianco	70,73 €
	ETS/3W/B/3/SE/AT/WH	EXIT S 3W LED 410 lm PREMIUM IP65 3h autonomia, SE, con AUTOTEST, colore Bianco	93,86 €
	ETS/3W/B/1/SA/AT/WH	EXIT S 3W LED 410 lm PREMIUM IP65 1h autonomia, SE + SA, con AUTOTEST, colore Bianco	73,04 €
	ETS/3W/B/3/SA/AT/WH	EXIT S 3W LED 410 lm PREMIUM IP65 3h autonomia, SE + SA, con AUTOTEST, colore Bianco	96,16 €
	ETSU/1W/B/1/SE/AT/WH	EXIT S con Ottica Universale 1W LED 180 lm PREMIUM IP65 1h autonomia, SE, con AUTOTEST, colore Bianco	94,89 €
	ETSU/1W/B/3/SE/AT/WH	EXIT S con Ottica Universale 1W LED 180 lm PREMIUM IP65 3h autonomia, SE, con AUTOTEST, colore Bianco	99,19 €
	ETSU/1W/B/1/SA/AT/WH	EXIT S con Ottica Universale 1W LED 180 lm PREMIUM IP65 1h autonomia, SE + SA, con AUTOTEST, colore Bianco	97,19 €
	ETSU/1W/B/3/SA/AT/WH	EXIT S con Ottica Universale 1W LED 180 lm PREMIUM IP65 3h autonomia, SE + SA, con AUTOTEST, colore Bianco	101,49 €
	ETSU/2W/B/1/SE/AT/WH	EXIT S con Ottica Universale 2W LED 340 lm PREMIUM IP65 1h autonomia, SE, con AUTOTEST, colore Bianco	83,66 €
	ETSU/2W/B/3/SE/AT/WH	EXIT S con Ottica Universale 2W LED 340 lm PREMIUM IP65 3h autonomia, SE, con AUTOTEST, colore Bianco	103,51 €
	ETSU/2W/B/1/SA/AT/WH	EXIT S con Ottica Universale 2W LED 340 lm PREMIUM IP65 1h autonomia, SE + SA, con AUTOTEST, colore Bianco	85,96 €
	ETSU/2W/B/3/SA/AT/WH	EXIT S con Ottica Universale 2W LED 340 lm PREMIUM IP65 3h autonomia, SE + SA, con AUTOTEST, colore Bianco	105,80 €
	ETSU/3W/B/1/SE/AT/WH	EXIT S con Ottica Universale 3W LED 430 lm PREMIUM IP65 1h autonomia, SE, con AUTOTEST, colore Bianco	103,51 €
	ETSU/3W/B/3/SE/AT/WH	EXIT S con Ottica Universale 3W LED 430 lm PREMIUM IP65 3h autonomia, SE, con AUTOTEST, colore Bianco	109,26 €
	ETSU/3W/B/1/SA/AT/WH	EXIT S con Ottica Universale 3W LED 430 lm PREMIUM IP65 1h autonomia, SE + SA, con AUTOTEST, colore Bianco	105,80 €
	ETSU/3W/B/3/SA/AT/WH	EXIT S con Ottica Universale 3W LED 430 lm PREMIUM IP65 3h autonomia, SE + SA, con AUTOTEST, colore Bianco	111,56 €
	ETSR/1W/B/1/SE/AT/WH	EXIT S con ottica per vie di fuga 1W LED 130 lm PREMIUM IP65 1h autonomia, SE, con AUTOTEST, colore Bianco	94,89 €
	ETSR/1W/B/3/SE/AT/WH	EXIT S con ottica per vie di fuga 1W LED 130 lm PREMIUM IP65 3h autonomia, SE, con AUTOTEST, colore Bianco	99,19 €
ETSR/1W/B/1/SA/AT/WH	EXIT S con ottica per vie di fuga 1W LED 130 lm PREMIUM IP65 1h autonomia, SE + SA, con AUTOTEST, colore Bianco	97,19 €	
ETSR/1W/B/3/SA/AT/WH	EXIT S con ottica per vie di fuga 1W LED 130 lm PREMIUM IP65 3h autonomia, SE + SA, con AUTOTEST, colore Bianco	101,49 €	
ETSR/2W/B/1/SA/AT/WH	EXIT S con ottica per vie di fuga 2W LED 335 lm PREMIUM IP65 1h autonomia, SE + SA, con AUTOTEST, colore Bianco	99,19 €	
ETSR/2W/B/3/SA/AT/WH	EXIT S con ottica per vie di fuga 2W LED 335 lm PREMIUM IP65 3h autonomia, SE + SA, con AUTOTEST, colore Bianco	103,51 €	
ETSR/3W/B/1/SE/AT/WH	EXIT S con ottica per vie di fuga 3W LED 410 lm PREMIUM IP65 1h autonomia, SE, con AUTOTEST, colore Bianco	103,51 €	
ETSR/3W/B/3/SE/AT/WH	EXIT S con ottica per vie di fuga 3W LED 410 lm PREMIUM IP65 3h autonomia, SE, con AUTOTEST, colore Bianco	109,26 €	
ETSR/3W/B/1/SA/AT/WH	EXIT S con ottica per vie di fuga 3W LED 410 lm PREMIUM IP65 1h autonomia, SE + SA, con AUTOTEST, colore Bianco	105,80 €	
ETSR/3W/B/3/SA/AT/WH	EXIT S con ottica per vie di fuga 3W LED 410 lm PREMIUM IP65 3h autonomia, SE + SA, con AUTOTEST, colore Bianco	111,56 €	

	CODICE ORDINE	EXIT S	LISTINO
		IP65	
CENTRAL BATTERY	ETS/1W/F/CB/X/WH	EXIT S 1W LED 170 lm IP65 per central battery system, colore bianco	62,67 €
	ETS/2W/F/CB/X/WH	EXIT S 2W LED 335 lm IP65 per central battery system, colore bianco	66,70 €
	ETS/3W/F/CB/X/WH	EXIT S 3W LED 410 lm IP65 per central battery system, colore bianco	70,73 €
	ETSR/1W/F/CB/X/WH	EXIT S con ottica per vie di fuga 2W LED 175 lm IP65 per central battery system, colore bianco	94,89 €
	ETSR/2W/F/CB/X/WH	EXIT S con ottica per vie di fuga 2W LED 335 lm IP65 per central battery system, colore bianco	99,19 €
	ETSR/3W/F/CB/X/WH	EXIT S con ottica per vie di fuga 3W LED 410 lm IP65 per central battery system, colore bianco	103,51 €
	ETSU/1W/F/CB/X/WH	EXIT S con Ottica Universale 1W LED 180 lm IP65 per central battery system, colore bianco	94,89 €
	ETSU/2W/F/CB/X/WH	EXIT S con Ottica Universale 2W LED 340 lm IP65 per central battery system, colore bianco	99,19 €
	ETSU/3W/F/CB/X/WH	EXIT S con Ottica Universale 2W LED 430 lm IP65 per central battery system, colore bianco	103,50 €
ACCESSORI	ETS/PLX	Kit di segnalazione PLEXI glass per EXIT S	10,71 €
	ETS/REC	kit incasso per EXIT S	12,36 €
	1012	Griglia di protezione per EXIT S	22,71 €
	ETE/PEN	kit a sospensione per EXIT	43,13 €

LEGGENDA:

SE	Emergenza	E	Apparecchio autonomo con elettronica tipo STANDARD
SA	Emergenza + SA	C	Apparecchio autonomo con elettronica tipo STANDARD
AT	autotest	B	Apparecchio autonomo con elettronica tipo PREMIUM
CB	central battery	F	Apparecchio NON AUTONOMO - Alimentazione centralizzata



EXIT S

AC
220-240V
50-60Hz

DC
176-275V

DC
24V

DC
48V

LED

IP65

IK07



d=20m



KM 618355
BS-EN 60598-2-22



MATERIALI

Bianco, Grigio o Nero in policarbonato • TCover trasparente o opale in policarbonato
• Plexiglass

MONTAGGI

Superficie • Opzione da incasso⁽¹⁾ • Opzione kit a sospensione⁽²⁾

ALIMENTAZIONE

Autonoma – 220 - 240VAC/50 - 60Hz
Central battery – 220 - 240VAC/50 - 60Hz; 176 - 275VDC
Central battery FZLV II – 48VDC *
Central battery FZLV – 24VDC *

SORGENTE

1W, 2W LED

RICARICA

Standard: max. 24h
Premium: max. 12h; charger a risparmio energetico

AUTONOMIA E BATTERIE

Standard: 1h o 3h, Ni-Cd 3,6V batteria
Premium: 1h o 3h, LiFePO₄ 6,4V batteria

CLASSE

II o III

GRADO IP & IK

IP65, IK08

DISTANZA DI VISIBILITA'

20 m

TIPOLOGIA

Singola o Doppia faccia⁽³⁾

TEMPERATURA

Autonoma: t_a: 0°C ÷ 40°C • t_b: -25°C ÷ 40°C – con sistema per gestione alle basse temperature
Central battery: t_b: -25°C ÷ 50°C

OPZIONI

SE – solo emergenza • SA – sempre accesa • AT – autotest • PT – pulsante di test
• CB – central battery • Versioni central test RUBIC o alimentazione e controllo centralizzato *

INFORMAZIONI

LED indicazione stato alimentazione e ricarica batteria • Protezione contro scarica profonda
• Opzione con adattatore per la gestione alle basse temperature fino a -25°C with HTR 25 (opzionale) • Classe di isolamento III per versione FZLV e FZLV2 • ⁽¹⁾ Vedi kit per incasso nella sezione accessori • ⁽²⁾ Vedi sezione accessori • ⁽³⁾ Vedi sezione accessori per pittogramma a doppia faccia • ⁽⁴⁾ 1pz di pittogramma universale è incluso in ogni confezione

* su richiesta

DIMENSIONI [mm]

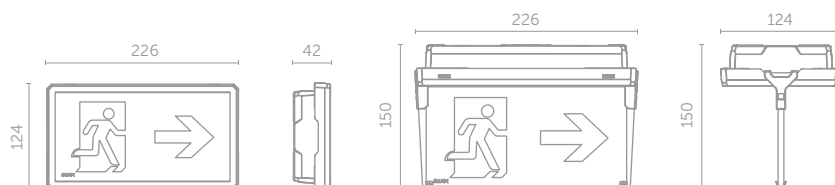

⁽⁴⁾ pittogramma incluso nelle versioni SA

EXIT M

AC
220-240V
50-60Hz

DC
176-275V

DC
24V

DC
48V

LED

IP65

IK08



KM 618355
BS-EN 60598-2-22



MATERIALI

Corpo Bianco, Grigio o Nero in policarbonato • Cover trasparente in policarbonato

MONTAGGI

Superficie • Opzione da incasso⁽¹⁾ • Opzione kit a sospensione⁽²⁾

ALIMENTAZIONE

Autonoma – 220 - 240VAC/50 - 60Hz
Central battery – 220 - 240VAC/50 - 60Hz; 176 - 275VDC
Central battery FZLV II – 48VDC *
Central battery FZLV – 24VDC *

SORGENTE

1W, 2W, 3W LED

RICARICA

Standard: max. 24h
Premium: max. 12h; charger a risparmio energetico

AUTONOMIA E BATTERIE

Standard: 1h o 3h, Ni-Cd 3,6V batteria
Premium: 1h o 3h, LiFePO₄ 6,4V batteria

CLASSE

II o III

GRADO IP & IK

IP65, IK08

TEMPERATURA

Autonoma: t_a: 0°C ÷ 40°C • t_b: -25°C ÷ 40°C – con sistema per gestione alle basse temperature
Central battery: t_b: -25°C ÷ 50°C

OPZIONI

SE – solo emergenza • SA – sempre accesa • AT – autotest • PT – pulsante di test
• CB – central battery • Versioni central test RUBIC o alimentazione e controllo centralizzato *

INFORMAZIONI

LED indicazione stato alimentazione e ricarica batteria • Protezione contro scarica profonda
• Opzione con adattatore per la gestione alla basse temperature fino a -25°C with HTR 25 (opzionale) • Classe di isolamento III per versione FZLV e FZLV2 • ⁽¹⁾ Vedi kit per incasso nella sezione accessori • ⁽²⁾ Vedi sezione accessori

* su richiesta

DIMENSIONI [mm]



	CODICE ORDINE	EXIT M	LISTINO
		IP65	
STANDARD	ETE/1W/C/1/SA/X/WH	EXIT 1W LED 170 lm STANDARD IP65 1h autonomia, SE + SA, colore Bianco	47,29 €
	ETE/1W/C/3/SA/X/WH	EXIT 1W LED 170 lm STANDARD IP65 3h autonomia, SE + SA, colore Bianco	50,31 €
	ETE/1W/E/1/SE/X/WH	EXIT 1W LED 170 lm STANDARD IP65 1h autonomia, solo Emergenza, colore Bianco	39,24 €
	ETE/1W/C/3/SE/X/WH	EXIT 1W LED 170 lm STANDARD IP65 3h autonomia, solo Emergenza, colore Bianco	41,26 €
	ETE/2W/C/1/SE/X/WH	EXIT 2W LED 285 lm STANDARD IP65 1h autonomia, SE, colore Bianco	52,33 €
	ETE/2W/C/3/SE/X/WH	EXIT 2W LED 285 lm STANDARD IP65 3h autonomia, SE, colore Bianco	56,35 €
	ETE/2W/C/1/SA/X/WH	EXIT 2W LED 285 lm STANDARD IP65 1h autonomia, SE + SA, colore Bianco	54,63 €
	ETE/2W/C/3/SA/X/WH	EXIT 2W LED 285 lm STANDARD IP65 3h autonomia, SE + SA, colore Bianco	58,65 €
	ETE/3W/C/1/SE/X/WH	EXIT 3W LED 395 lm STANDARD IP65 1h autonomia, SE, colore Bianco	57,36 €
	ETE/3W/C/3/SE/X/WH	EXIT 3W LED 395 lm STANDARD IP65 3h autonomia, SE, colore Bianco	69,44 €
	ETE/3W/C/1/SA/X/WH	EXIT 3W LED 395 lm STANDARD IP65 1h autonomia, SE + SA, colore Bianco	59,66 €
	ETE/3W/C/3/SA/X/WH	EXIT 3W LED 395 lm STANDARD IP65 3h autonomia, SE + SA, colore Bianco	71,75 €
PREMIUM CON AUTOTEST	ETE/1W/B/1/SE/AT/WH	EXIT 1W LED 175 lm PREMIUM IP65 1h autonomia, SE, con AUTOTEST, colore Bianco	68,43 €
	ETE/1W/B/3/SE/AT/WH	EXIT 1W LED 175 lm PREMIUM IP65 3h autonomia, SE, con AUTOTEST, colore Bianco	72,45 €
	ETE/1W/B/1/SA/AT/WH	EXIT 1W LED 175 lm PREMIUM IP65 1h autonomia, SE + SA, con AUTOTEST, colore Bianco	70,73 €
	ETE/1W/B/3/SA/AT/WH	EXIT 1W LED 175 lm PREMIUM IP65 3h autonomia, SE + SA, con AUTOTEST, colore Bianco	74,75 €
	ETE/2W/B/1/SE/AT/WH	EXIT 2W LED 340 lm PREMIUM IP65 1h autonomia, SE, con AUTOTEST, colore Bianco	72,45 €
	ETE/2W/B/3/SE/AT/WH	EXIT 2W LED 340 lm PREMIUM IP65 3h autonomia, SE, con AUTOTEST, colore Bianco	76,48 €
	ETE/2W/B/1/SA/AT/WH	EXIT 2W LED 340 lm PREMIUM IP65 1h autonomia, SE + SA, con AUTOTEST, colore Bianco	74,75 €
	ETE/2W/B/3/SA/AT/WH	EXIT 2W LED 340 lm PREMIUM IP65 3h autonomia, SE + SA, con AUTOTEST, colore Bianco	78,78 €
	ETE/3W/B/1/SE/AT/WH	EXIT 3W LED 410 lm PREMIUM IP65 1h autonomia, SE, con AUTOTEST, colore Bianco	76,48 €
	ETE/3W/B/3/SE/AT/WH	EXIT 3W LED 410 lm PREMIUM IP65 3h autonomia, SE, con AUTOTEST, colore Bianco	99,62 €
	ETE/3W/B/1/SA/AT/WH	EXIT 3W LED 410 lm PREMIUM IP65 1h autonomia, SE + SA, con AUTOTEST, colore Bianco	78,78 €
	ETE/3W/B/3/SA/AT/WH	EXIT 3W LED 410 lm PREMIUM IP65 3h autonomia, SE + SA, con AUTOTEST, colore Bianco	101,92 €

	CODICE ORDINE	EXIT M	LISTINO
		IP65	
CENTRAL BATTERY	ETE/1W/F/CB/X/WH	EXIT 1W LED 175 lm IP65 per central battery system, colore Bianco	68,43 €
	ETE/2W/F/CB/X/WH	EXIT 2W LED 340 lm IP65 per central battery system, colore Bianco	72,45 €
	ETE/3W/F/CB/X/WH	EXIT 3W LED 410 lm IP65 per central battery system, colore Bianco	76,48 €
ACCESSORI	ETE/PEN	kit a sospensione per EXIT	43,13 €
	ETE/PLX	Kit di segnalazione PLEXI glass per EXIT M	10,71 €
	ETE/REC	kit incasso per EXIT M	12,36 €
	1013	Griglia di protezione per EXIT M	25,88 €

LEGGENDA:

SE	Emergenza	E	Apparecchio autonomo con elettronica tipo STANDARD
SA	Emergenza + SA	C	Apparecchio autonomo con elettronica tipo STANDARD
AT	autotest	B	Apparecchio autonomo con elettronica tipo PREMIUM
CB	central battery	F	Apparecchio NON AUTONOMO - Alimentazione centralizzata



EXIT L

AC
220-240V
50-60Hz

DC
176-275V

DC
24V

DC
48V

LED

IP65

IK08

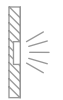
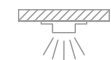

KM 618355
BS-EN 60598-2-22



MATERIALI

Corpo Bianco, Grigio o Nero in policarbonato • Cover trasparente in policarbonato

MONTAGGI

Superficie • Opzione da incasso⁽¹⁾ • Opzione kit a sospensione⁽²⁾

ALIMENTAZIONE

Autonoma – 220 - 240VAC/50 - 60Hz
Central battery – 220 - 240VAC/50 - 60Hz; 176 - 275VDC
Central battery FZLV II – 48VDC *
Central battery FZLV – 24VDC *

SORGENTE

1W, 2W, 3W, 6W LED

RICARICA

Standard: max. 24h
Premium: max. 12h; charger a risparmio energetico

AUTONOMIA E BATTERIE

Standard: 1h o 3h, Ni-Cd 3,6V batteria
Premium: 1h o 3h, LiFePO₄ 6,4V batteria

CLASSE

II o III

GRADO IP & IK

IP65, IK08

TEMPERATURA

Autonoma: t_3 : 0°C ÷ 40°C • t_5 : -25°C ÷ 40°C – con sistema per gestione alle basse temperature
Central battery: t_3 : -25°C ÷ 50°C

OPZIONI

SE – solo emergenza • SA – sempre accesa • AT – autotest • PT – pulsante di test
• CB – central battery • Versioni central test RUBIC o alimentazione e controllo centralizzato *

INFORMAZIONI

LED indicazione stato alimentazione e ricarica batteria • Protezione contro scarica profonda
• Opzione con adattatore per la gestione alla basse temperature fino a -25°C with HTR 25 (opzionale) • Classe di isolamento III per versione FZLV e FZLV2 • ⁽¹⁾ Vedi kit per incasso nella sezione accessori • ⁽²⁾ Vedi sezione accessori

* su richiesta

DIMENSIONI [mm]



	CODICE ORDINE	EXIT L	LISTINO
		IP65	
STANDARD	ETL/1W/C/1/SA/X/WH	EXIT L 1W LED 170 lm STANDARD IP65 1h autonomia, SE + SA, colore Bianco	54,49 €
	ETL/1W/C/3/SA/X/WH	EXIT L 1W LED 170 lm STANDARD IP65 3h autonomia, SE + SA, colore Bianco	57,50 €
	ETL/1W/E/1/SE/X/WH	EXIT L 1W LED 170 lm STANDARD IP65 1h autonomia, solo Emergenza, colore Bianco	46,43 €
	ETL/1W/E/3/SE/X/WH	EXIT L 1W LED 170 lm STANDARD IP65 3h autonomia, solo Emergenza, colore Bianco	48,45 €
	ETL/2W/C/1/SE/X/WH	EXIT L 2W LED 285 lm STANDARD IP65 1h autonomia, SE, colore Bianco	59,52 €
	ETL/2W/C/3/SE/X/WH	EXIT L 2W LED 285 lm STANDARD IP65 3h autonomia, SE, colore Bianco	63,54 €
	ETL/2W/C/1/SA/X/WH	EXIT L 2W LED 285 lm STANDARD IP65 1h autonomia, SE + SA, colore Bianco	61,81 €
	ETL/2W/C/3/SA/X/WH	EXIT L 2W LED 285 lm STANDARD IP65 3h autonomia, SE + SA, colore Bianco	65,84 €
	ETL/3W/C/1/SE/X/WH	EXIT L 3W LED 430 lm STANDARD IP65 1h autonomia, SE, colore Bianco	64,55 €
	ETL/3W/C/3/SE/X/WH	EXIT L 3W LED 430 lm STANDARD IP65 3h autonomia, SE, colore Bianco	76,62 €
	ETL/3W/C/1/SA/X/WH	EXIT L 3W LED 430 lm STANDARD IP65 1h autonomia, SE + SA, colore Bianco	66,85 €
	ETL/3W/C/3/SA/X/WH	EXIT L 3W LED 430 lm STANDARD IP65 3h autonomia, SE + SA, colore Bianco	78,92 €
PREMIUM CON AUTOTEST	ETL/1W/B/1/SE/AT/WH	EXIT L 1W LED 180 lm PREMIUM IP65 1h autonomia, SE + SA, con AUTOTEST, colore Bianco	75,62 €
	ETL/1W/B/3/SE/AT/WH	EXIT L 1W LED 180 lm PREMIUM IP65 3h autonomia, SE + SA, con AUTOTEST, colore Bianco	79,64 €
	ETL/1W/B/1/SA/AT/WH	EXIT L 1W LED 180 lm PREMIUM IP65 1h autonomia, SE + SA, con AUTOTEST, colore Bianco	77,92 €
	ETL/1W/B/3/SA/AT/WH	EXIT L 1W LED 180 lm PREMIUM IP65 3h autonomia, SE + SA, con AUTOTEST, colore Bianco	81,95 €
	ETL/2W/B/1/SE/AT/WH	EXIT L 2W LED 340 lm PREMIUM IP65 1h autonomia, SE, con AUTOTEST, colore Bianco	79,64 €
	ETL/2W/B/3/SE/AT/WH	EXIT L 2W LED 340 lm PREMIUM IP65 3h autonomia, SE, con AUTOTEST, colore Bianco	83,67 €
	ETL/2W/B/1/SA/AT/WH	EXIT L 2W LED 340 lm PREMIUM IP65 1h autonomia, SE + SA, con AUTOTEST, colore Bianco	81,95 €
	ETL/2W/B/3/SA/AT/WH	EXIT L 2W LED 340 lm PREMIUM IP65 3h autonomia, SE + SA, con AUTOTEST, colore Bianco	85,97 €
	ETL/3W/B/1/SE/AT/WH	EXIT L 3W LED 455 lm PREMIUM IP65 1h autonomia, SE, con AUTOTEST, colore Bianco	83,67 €
	ETL/3W/B/3/SE/AT/WH	EXIT L 3W LED 455 lm PREMIUM IP65 3h autonomia, SE, con AUTOTEST, colore Bianco	106,81 €
	ETL/3W/B/1/SA/AT/WH	EXIT L 3W LED 455 lm PREMIUM IP65 1h autonomia, SE + SA, con AUTOTEST, colore Bianco	85,97 €
	ETL/3W/B/3/SA/AT/WH	EXIT L 3W LED 455 lm PREMIUM IP65 3h autonomia, SE + SA, con AUTOTEST, colore Bianco	109,11 €
	ETL/6W/B/1/SE/AT/WH	EXIT L 6W LED 850 lm, ALTO FLUSSO PREMIUM IP65 1h autonomia, SE, con AUTOTEST, colore Bianco	131,98 €
	ETL/6W/B/3/SE/AT/WH	EXIT L 6W LED 850 lm ALTO FLUSSO PREMIUM IP65 3h autonomia, SE, con AUTOTEST, colore Bianco	180,57 €
	ETL/6W/B/1/SA/AT/WH	EXIT L 6W LED 850 lm, ALTO FLUSSO PREMIUM IP65 1h autonomia, SE + SA, con AUTOTEST, colore Bianco	134,27 €
	ETL/6W/B/3/SA/AT/WH	EXIT L 6W LED 850 lm ALTO FLUSSO PREMIUM IP65 3h autonomia, SE + SA, con AUTOTEST, colore Bianco	182,87 €

	CODICE ORDINE	EXIT L	LISTINO
		IP65	
CENTRAL BATTERY	ETL/1W/F/CB/X/WH	EXIT L 1W LED 180 lm IP65 per central battery system, colore Bianco	136,10 €
	ETL/2W/F/CB/X/WH	EXIT L 2W LED 340 lm IP65 per central battery system, colore Bianco	143,35 €
	ETL/3W/F/CB/X/WH	EXIT L 3W LED 455 lm IP65 per central battery system, colore Bianco	150,59 €
	ETL/6W/F/CB/X/WH	EXIT L 3W LED 850 lm ALTO FLUSSO IP65 per central battery system, colore Bianco	237,53 €
ACCESSORI	ETE/PEN	kit a sospensione per EXIT	43,13 €
	ETL/PLX	Kit di segnalazione EXIT L	13,80 €
	ETL/REC	kit incasso per EXIT L	12,36 €
	1014	Griglia di protezione perEXIT L	28,75 €

LEGGENDA:

SE	Emergenza	E	Apparecchio autonomo con elettronica tipo STANDARD
SA	Emergenza + SA	C	Apparecchio autonomo con elettronica tipo STANDARD
AT	autotest	B	Apparecchio autonomo con elettronica tipo PREMIUM
CB	central battery	F	Apparecchio NON AUTONOMO - Alimentazione centralizzata



EXIT accessori



ACCESSORI PER INCASSO

CODICE: ETS/REC – EXIT S
ETE/REC – EXIT M
ETL/REC – EXIT L

DIMENSIONI [mm]

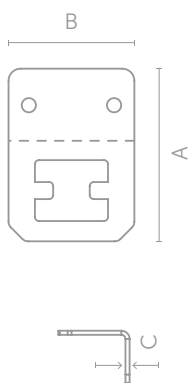

Dimensioni: (Ax BxC):

EXIT S: 36x36x1,5

EXIT M: 42x31x1,5

EXIT L: 37x34x1,5

ADATTABILE A EXIT S, M, L



CORNICE PER INSTALLAZIONE IN CONTROSOFFITTO

CODICE: ETS/REC2

DIMENSIONI [mm]

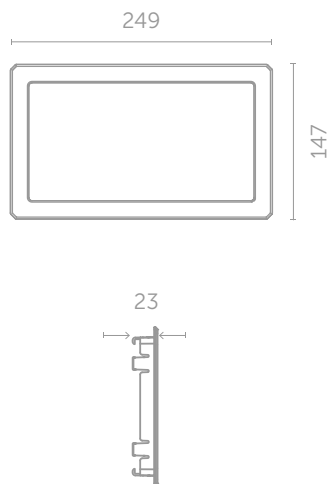

ADATTABILE A EXIT S



STAFFA PER INSTALLAZIONE A SOSPENSIONE

CODICE: ETE/PEN2

DIMENSIONI [mm]

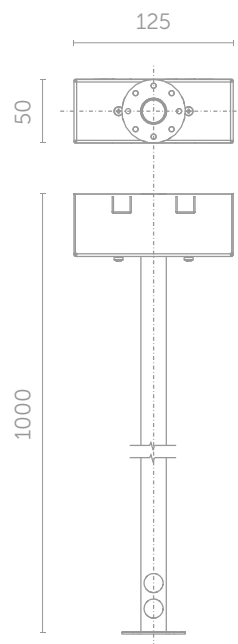

ADATTABILE A EXIT S, M, L





PLEXIGLASS

CODICE: ETE/PLX

* 1PZ DI PITTOGRAMMA UNIVERSALE E'
INCLUSO IN OGNI CONFEZIONE

DIMENSIONI [mm]

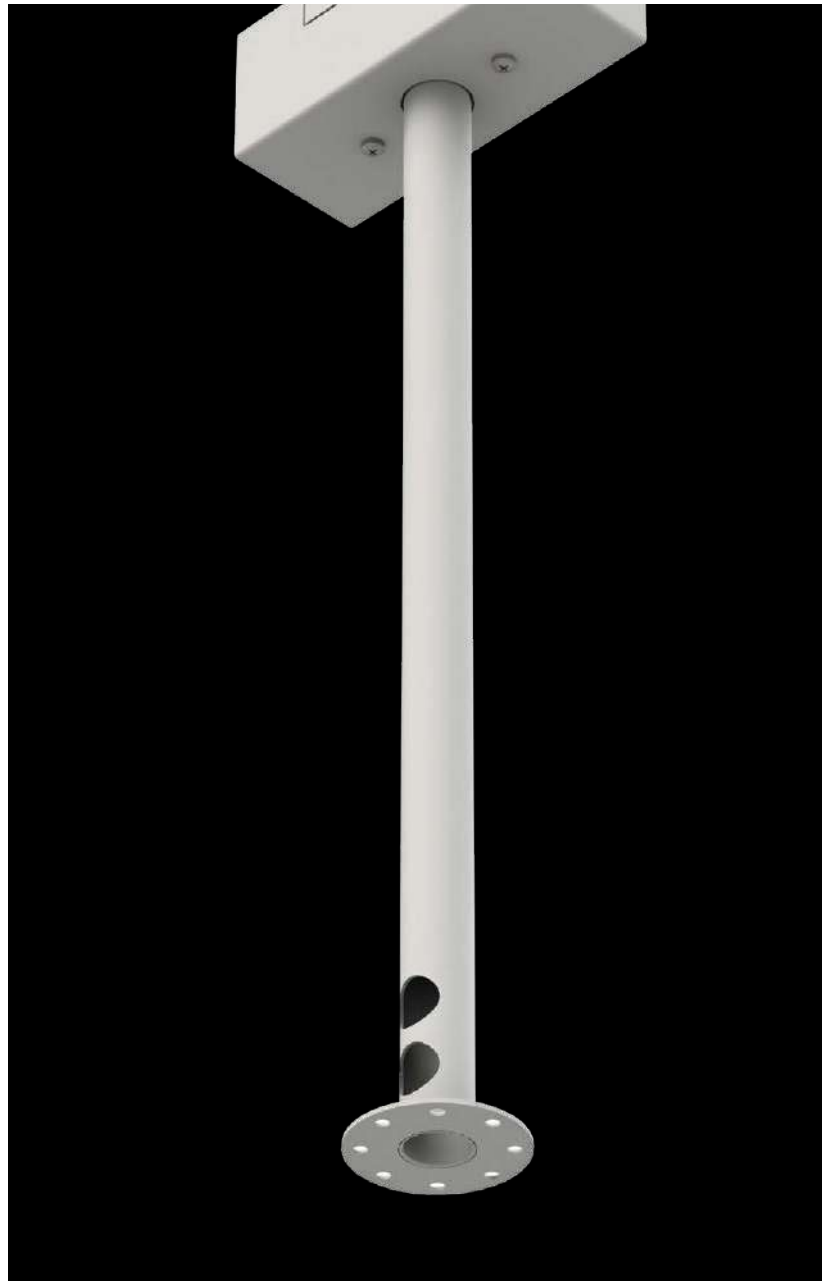
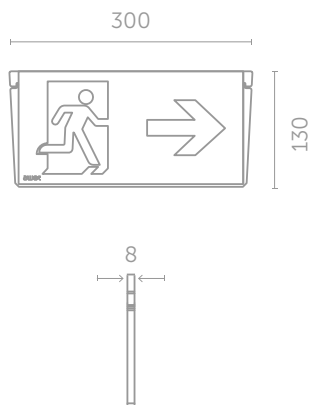

ADATTABILE A EXIT M





PLEXIGLASS

CODICE: ETS/PLX - EXIT S

ETL/PLX - EXIT L

* 1PZ DI PITTOGRAMMA UNIVERSALE E' INCLUSO IN OGNI CONFEZIONE

DIMENSIONI [mm]

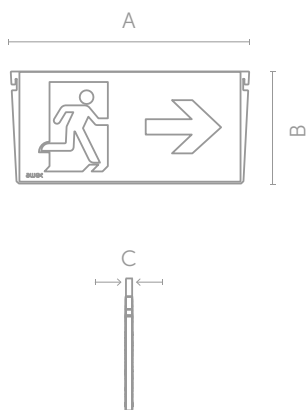

Dimensioni: (AxBxC):

EXIT S: 224x107x6

EXIT L: 330x155x8

ADATTABILE A EXIT S, L



SUPPORTO PER INCLINAZIONE LAMPADA 0-90°

CODICE: 3001

DIMENSIONI [mm]

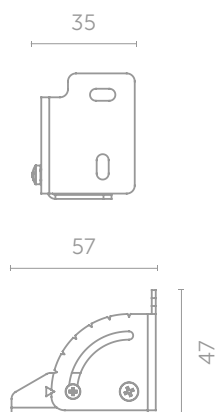

ADATTABILE A EXIT M, L

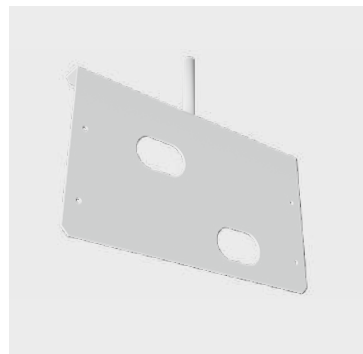

KIT A SOSPENSIONE CON STAFFA

CODICE: 2945 - EXIT S

2946 - EXIT M

2947 - EXIT L

DIMENSIONI [mm]

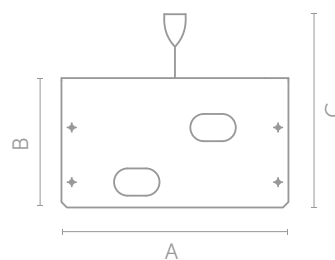

Dimensioni (mm): (AxBxC):

EXIT S: 202x121x428

EXIT M: 250x142x449

EXIT L: 300x172x479

ADATTABILE A EXIT S, M, L



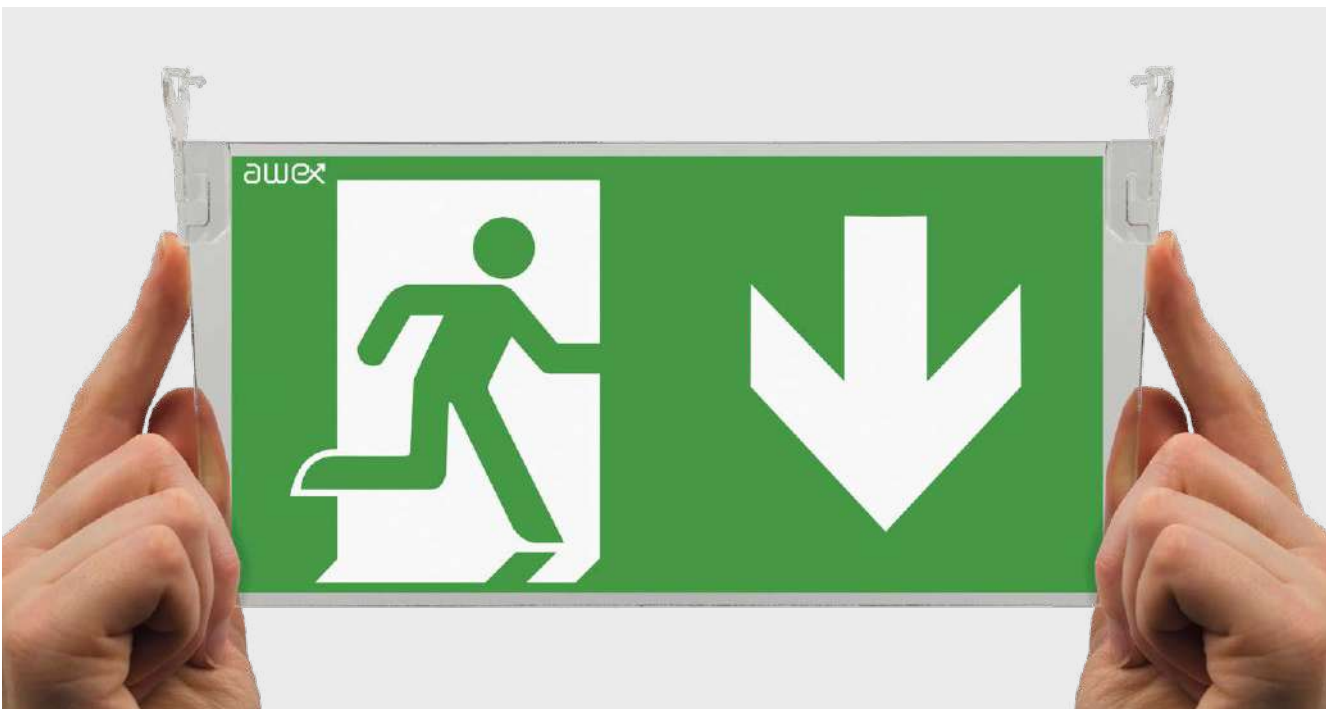

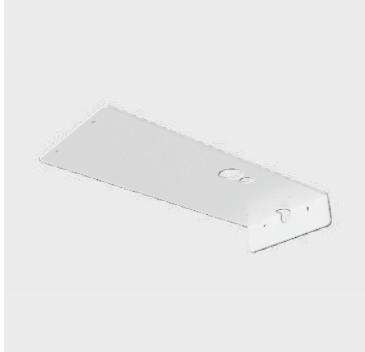

STAFFA A PARETE

CODICE: 1906 – EXIT S
 1907 – EXIT M / EXIT M DS
 1908 – EXIT L

DIMENSIONI [mm]

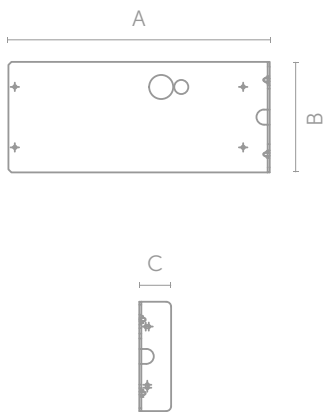

Dimensioni (mm): (AxBxC):
 EXIT S: 202x121x26
 EXIT M: 250x142x33
 EXIT L: 300x172x33

ADATTABILE A EXIT S, M, L

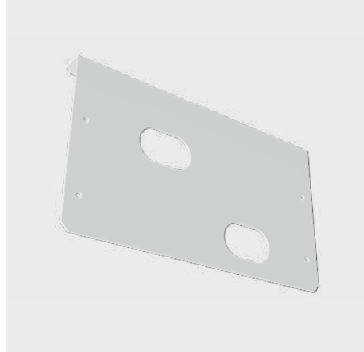

STAFFA A SOFFITTO

CODICE: 1903 – EXIT S
 1904 – EXIT M / EXIT M DS
 1905 – EXIT L

DIMENSIONI [mm]

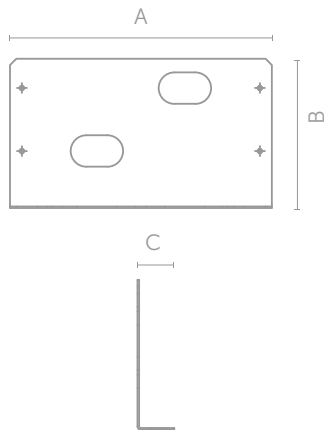

Dimensioni (mm): (AxBxC):
 EXIT S: 202x121x26
 EXIT M: 250x142x33
 EXIT L: 300x172x33

ADATTABILE A EXIT S, M, L



ACCESSORIO PER INSTALLAZIONE CON CATENE A

CODICE: ET/ALIN

DIMENSIONI [mm]

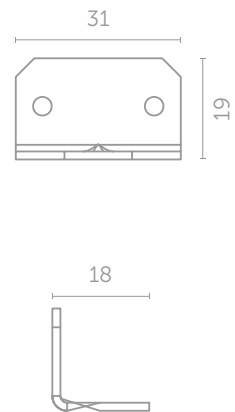

ADATTABILE A EXIT M, L



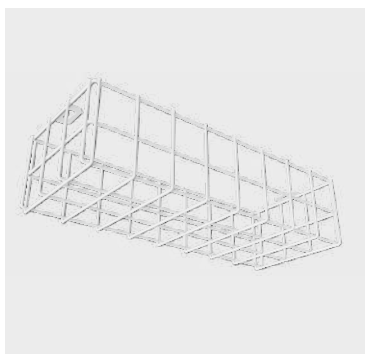

GRIGLIA DI PROTEZIONE

CODICE: 1012 – EXIT S
1013 – EXIT M
1014 – EXIT L

DIMENSIONI [mm]

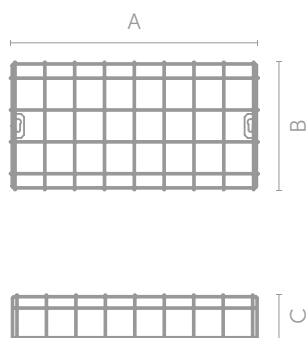

Dimensioni: (AxBxC):
EXIT S: 255x145x60
EXIT M: 305x200x60
EXIT L: 415x215x75

ADATTABILE A EXIT S, M, L

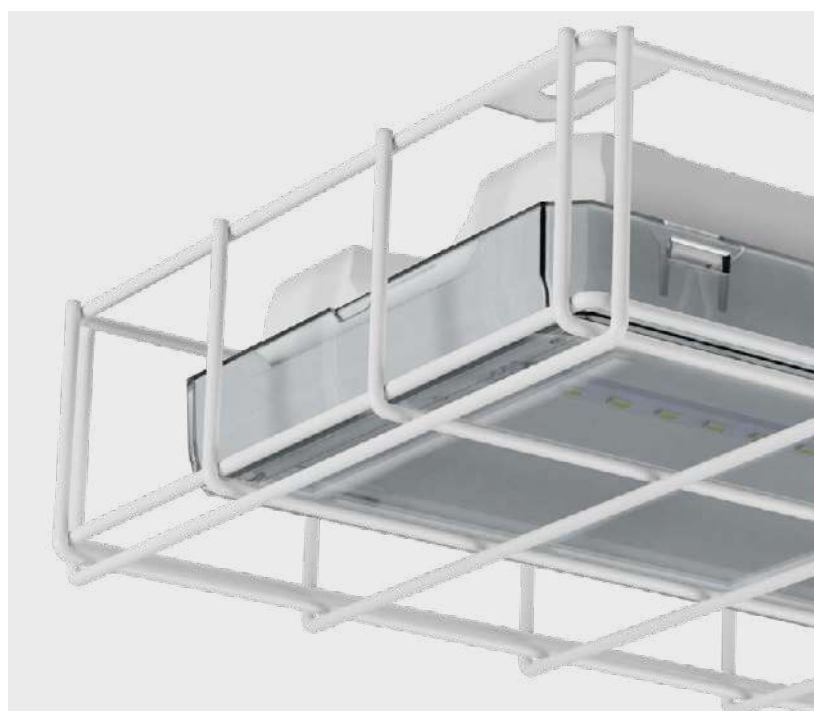

WONDER



AC
220-240V
50-60Hz

LED

IP20

IK08

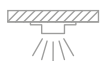

MATERIALI

Corpo Bianco in policarbonato
Opal o Cover in policarbonato

MONTAGGI

Superficie
Opzione da incasso ⁽¹⁾
Opzione da incasso controsoffitto ⁽²⁾

ALIMENTAZIONE

Autonoma – 220 - 240VAC/50 - 60Hz

SORGENTE

1W, 2W, 3W LED

RICARICA

max. 12/24h

AUTONOMIA E BATTERIE

1h o 3h, 3,6V batteria

CLASSE

II

GRADO IP & IK

IP20, IK08

TEMPERATURA

t_a: 0°C ÷ 40°C

OPZIONI

SE – solo emergenza • SA – sempre accesa • PT – pulsante di test

INFORMAZIONI

LED indicazione stato alimentazione e ricarica batteria • Protezione contro scarica profonda • Optional connection to Inhibit o telecomando (opzione) • ⁽¹⁾ Vedi accessori per installazione a incasso O • ⁽²⁾ Vedi accessori per incasso filo muro

DIMENSIONI [mm]

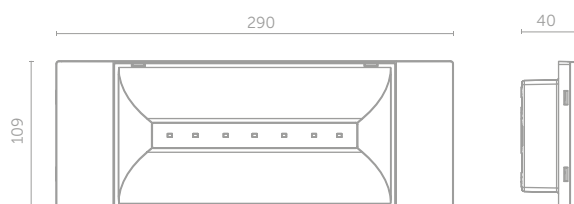

	CODICE ORDINE	WONDER	LISTINO
		IP40/IP20	
STANDARD	WND1WC1MWO	Wonder 1W LED 170 lm STANDARD IP40/ IP20 1h autonomia, SE + SA, colore Bianco, plafoniera opale	25,75 €
	WND1WC15MWO	Wonder 1W LED 170 lm STANDARD IP40/ IP20 1,5h autonomia, SE + SA, colore Bianco, plafoniera opale	28,24 €
	WND1WC3MWO	Wonder 1W LED 170 lm STANDARD IP40/ IP20 3h autonomia, SE + SA, colore Bianco, plafoniera opale	30,74 €
	WND2WC1MWO	Wonder 2W LED 290 lm STANDARD IP40/ IP20 1h autonomia, SE + SA, colore Bianco, plafoniera opale	38,50 €
	WND2WC15MWO	Wonder 2W LED 290 lm STANDARD IP40/ IP20 1,5h autonomia, SE + SA, colore Bianco, plafoniera opale	43,50 €
	WND2WC3MWO	Wonder 2W LED 290 lm STANDARD IP40/ IP20 3h autonomia, SE + SA, colore Bianco, plafoniera opale	48,50 €
	WND3WC1MWO	Wonder 3W LED 390 lm STANDARD IP40/ IP20 1h autonomia, SE + SA, colore Bianco, plafoniera opale	46,00 €
	WND3WC15MWO	Wonder 3W LED 390 lm STANDARD IP40/ IP20 1,5h autonomia, SE + SA, colore Bianco, plafoniera opale	51,00 €

	CODICE ORDINE	ACCESSORI	LISTINO
	WNDREC	Kit per installazione in controsoffitto per Wonder	6,50 €
	WNRWC	Scatola incasso filomuro per Wonder	3,50 €
	WNDPLX	Kit di segnalazione bifacciale	12,50 €
	1909	Kit per fissaggio a bandiera	12,50 €

LEGGENDA:

SE	Emergenza	E	Apparecchio autonomo con elettronica tipo STANDARD
SA	Emergenza + SA	C	Apparecchio autonomo con elettronica tipo STANDARD
AT	autotest	B	Apparecchio autonomo con elettronica tipo PREMIUM
CB	central battery	F	Apparecchio NON AUTONOMO - Alimentazione centralizzata

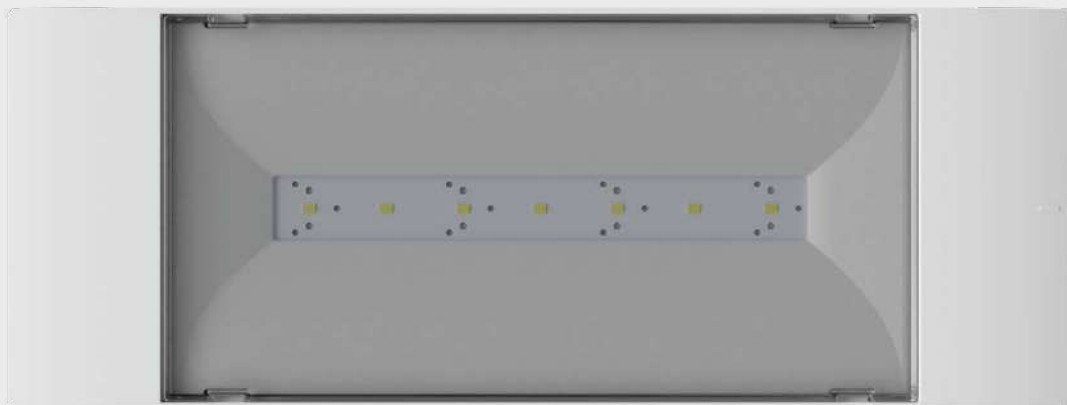

WONDER accessori



ACCESSORIO PER INCASSO IN CONTROSOFFITTO (SET)

CODICE: WND/REC

DIMENSIONI [mm]

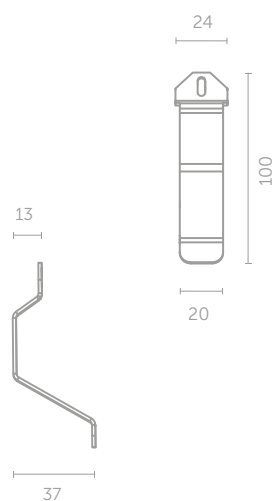

ADATTABILE A WONDER (WND, WNDO)



SCATOLA FILO MURO

CODICE: WND/RWC

DIMENSIONI [mm]

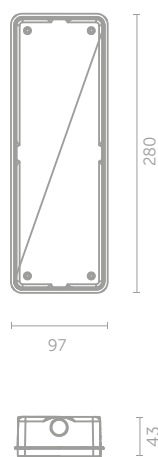

ADATTABILE A WONDER (WND, WNDO)



PLEXI GLASS (SET)

CODICE: WND/PLX

* 1PZ PITTOGRAMMA UNIVERSALE
INCLUSA IN OGNI CONFEZIONE

DIMENSIONI [mm]

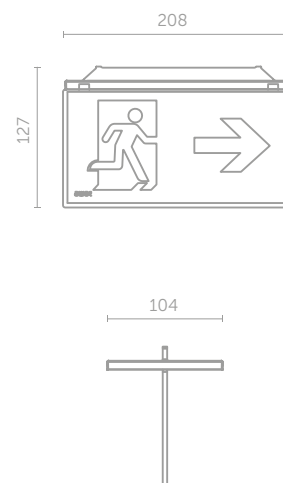

ADATTABILE A WONDER (WND)





STAFFA A BANDIERA

CODICE: 1909

DIMENSIONI [mm]

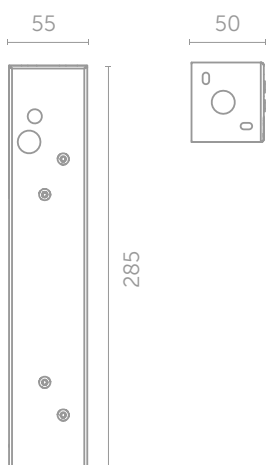

ADATTABILE A WONDER (WND)



ARROW N



AC
220-240V
50-60Hz

DC
176-275V

DC
24V

DC
48V

LED

IP40

IK08



d=25m



KM 618355
BS-EN 60598-2-22



MATERIALI

Corpo Bianco, Grigio o Nero in policarbonato • Plexiglass

MONTAGGI

Superficie ⁽¹⁾

ALIMENTAZIONE

Autonoma – 220 - 240VAC/50 - 60Hz
Central battery – 220 - 240VAC/50 - 60Hz; 176 - 275VDC
Central battery FZLV II – 48VDC *
Central battery FZLV – 24VDC *

SORGENTE

1W, 2W LED

RICARICA

Standard: max. 24h

Premium: max. 12h; charger a risparmio energetico

AUTONOMIA E BATTERIE

Standard: 1h o 3h, Ni-Cd 3,6V batteria

Premium: 1h o 3h, LiFePO₄ 6,4V batteria

CLASSE

II o III

GRADO IP & IK

IP40, IK08

DISTANZA DI VISIBILITA'

25 m

TIPOLOGIA

Doppia faccia

TEMPERATURA

Autonoma: t_a: 0°C ÷ 40°C

Central battery: t_a: 0°C ÷ 50°C

OPZIONI

SE – solo emergenza • SA – sempre accesa • AT – autotest • PT – pulsante di test
• CB – central battery • Versioni central test RUBIC o alimentazione e controllo centralizzato *

INFORMAZIONI

LED indicazione stato alimentazione e ricarica batteria • Protezione contro scarica profonda
• Classe di isolamento III per versione FZLV e FZLV2 • ⁽¹⁾ 1pz di pittogramma universale è incluso in ogni confezione

* su richiesta

DIMENSIONI [mm]

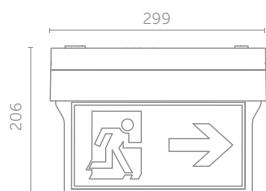

⁽²⁾ pittogramma

	CODICE ORDINE	ARROW N	LISTINO
		IP40	
STANDARD	ARN/1W/C/1/SA/X/WH	ARROW N 1W LED STANDARD IP40 1h autonomia, SE + SA, colore Bianco	50,30 €
	ARN/1W/C/3/SA/X/WH	ARROW N 1W LED STANDARD IP40 3h autonomia, SE + SA, colore Bianco	53,19 €
	ARN/2W/C/1/SA/X/WH	ARROW N 2W LED STANDARD IP40 1h autonomia, SE + SA, colore Bianco	52,37 €
	ARN/2W/C/3/SA/X/WH	ARROW N 2W LED STANDARD IP40 3h autonomia, SE + SA, colore Bianco	72,84 €
PREMIUM CON AUTOTEST	ARN/1W/B/1/SA/AT/WH	ARROW N 1W LED PREMIUM IP40 1h autonomia, SE + SA, con AUTOTEST, colore Bianco	73,90 €
	ARN/1W/B/3/SA/AT/WH	ARROW N 1W LED PREMIUM IP40 3h autonomia, SE + SA, con AUTOTEST, colore Bianco	77,35 €
	ARN/2W/B/1/SA/AT/WH	ARROW N 2W LED PREMIUM IP40 1h autonomia, SE + SA, con AUTOTEST, colore Bianco	77,64 €
	ARN/2W/B/3/SA/AT/WH	ARROW N 2W LED PREMIUM IP40 3h autonomia, SE + SA, con AUTOTEST, colore Bianco	97,87 €
CENTRAL BATTERY	ARN/1W/F/CB/X/WH	ARROW N 1W LED IP40 per central battery system, colore Bianco	73,90 €
	ARN/2W/F/CB/X/WH	ARROW N 2W LED IP40 per central battery system, colore Bianco	77,64 €

LEGGENDA:

SE	Emergenza	E	Apparecchio autonomo con elettronica tipo STANDARD
SA	Emergenza + SA	C	Apparecchio autonomo con elettronica tipo STANDARD
AT	autotest	B	Apparecchio autonomo con elettronica tipo PREMIUM
CB	central battery	F	Apparecchio NON AUTONOMO - Alimentazione centralizzata



ARROW P



AC
220-240V
50-60Hz

DC
176-275V

DC
24V

DC
48V

LED

IP40

IK08



d=25m



Ni-Cd

LiFePO₄



KM 618355
BS-EN 60598-2-22



MATERIALI

Bianco, Grigio o Nero polycarbonate body • Plexiglass

MONTAGGI

Incasso

ALIMENTAZIONE

Autonoma – 220 - 240VAC/50 - 60Hz
Central battery – 220 - 240VAC/50 - 60Hz; 176 - 275VDC
Central battery FZLV II – 48VDC *
Central battery FZLV – 24VDC *

SORGENTE

1W, 2W LED
Colour temperature: 6000K
Lifetime: 50000h

RICARICA

Standard: max. 24h
Premium: max. 12h; charger a risparmio energetico

AUTONOMIA E BATTERIE

Standard: 1h o 3h, Ni-Cd 3,6V batteria
Premium: 1h o 3h, LiFePO₄ 6,4V batteria

CLASSE

II o III

GRADO IP & IK

IP40, IK08

DISTANZA DI VISIBILITA'

25 m

TIPOLOGIA

Doppia faccia

TEMPERATURA

Autonoma: t_a: 0°C ÷ 40°C
Central battery: t_a: 0°C ÷ 50°C

OPZIONI

SE – solo emergenza • SA – sempre accesa • AT – autotest • PT – pulsante di test
• CB – central battery • Versioni central test RUBIC o alimentazione e controllo centralizzato *

INFORMAZIONI

LED indicazione stato alimentazione e ricarica batteria • Protezione contro scarica profonda
• Classe di isolamento III per versione FZLV e FZLV2 • ⁽¹⁾ 1pz di pittogramma universale è incluso in ogni confezione

* su richiesta

DIMENSIONI [mm]

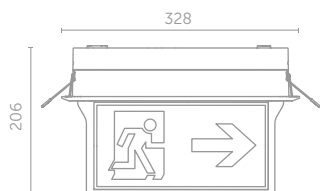

⁽¹⁾ pittogramma

	CODICE ORDINE	ARROW P	LISTINO
		IP40	
STANDARD	ARP/1W/C/1/SA/X/WH	ARROW P 1W LED STANDARD IP40 1h autonomia, SE + SA, colore Bianco	56,85 €
	ARP/1W/C/3/SA/X/WH	ARROW P 1W LED STANDARD IP40 3h autonomia, SE + SA, colore Bianco	56,64 €
	ARP/1W/E/3/SE/X/WH	ARROW P 1W LED STANDARD IP40 3h autonomia, solo Emergenza, colore Bianco	49,09 €
	ARP/2W/C/1/SA/X/WH	ARROW P 2W LED STANDARD IP40 1h autonomia, SE + SA, colore Bianco	55,83 €
	ARP/2W/C/3/SA/X/WH	ARROW P 2W LED STANDARD IP40 3h autonomia, SE + SA, colore Bianco	76,29 €
PREMIUM CON AUTOTEST	ARP/1W/B/1/SA/AT/WH	ARROW P 1W LED PREMIUM IP40 1h autonomia, SE + SA, con AUTOTEST, colore Bianco	77,35 €
	ARP/1W/B/3/SA/AT/WH	ARROW P 1W LED PREMIUM IP40 3h autonomia, SE + SA, con AUTOTEST, colore Bianco	80,79 €
	ARP/2W/B/1/SA/AT/WH	ARROW P 2W LED PREMIUM IP40 1h autonomia, SE + SA, con AUTOTEST, colore Bianco	81,09 €
	ARP/2W/B/3/SA/AT/WH	ARROW P 2W LED PREMIUM IP40 3h autonomia, SE + SA, con AUTOTEST, colore Bianco	101,33 €
CENTRAL BATTERY	ARP/1W/F/CB/X/WH	ARROW P 1W LED IP40 per central battery system, colore Bianco	77,35 €
	ARP/2W/F/CB/X/WH	ARROW P 2W LED IP40 per central battery system, colore Bianco	81,09 €

LEGGENDA:

SE	Emergenza	E	Apparecchio autonomo con elettronica tipo STANDARD
SA	Emergenza + SA	C	Apparecchio autonomo con elettronica tipo STANDARD
AT	autotest	B	Apparecchio autonomo con elettronica tipo PREMIUM
CB	central battery	F	Apparecchio NON AUTONOMO - Alimentazione centralizzata



ARROW accessori



ACCESSORIO PER INSTALLAZIONE SU BINARIO (SET)

CODICE: ARN/EUT/WH
ARN/EUT/GR
ARN/EUT/BL

DIMENSIONI [mm]

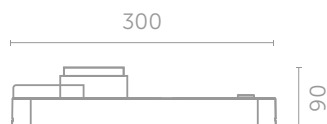

ADATTABILE A ARROW N



KIT SOSPENSIONE

CODICE: 1006/WH
1006/GR
1006/BL

DIMENSIONI [mm]



ADATTABILE A ARROW N





INFINITY II B



AC
220-240V
50-60Hz

DC
176-275V

DC
24V

DC
48V

LED

IP40

IK08



d=30m



Ni-Cd

LiFePO₄



KM 618355
BS-EN 60598-2-22



MATERIALI

Corpo Bianco, Grigio o Nero in policarbonato • Plexiglass

MONTAGGI

Superficie • Incasso ⁽¹⁾

ALIMENTAZIONE

Autonoma – 220 - 240VAC/50 - 60Hz
Central battery – 220 - 240VAC/50 - 60Hz; 176 - 275VDC
Central battery FZLV II – 48VDC *
Central battery FZLV – 24VDC *

SORGENTE

1W, 2W LED

RICARICA

Standard: max. 24h
Premium: max. 12h; charger a risparmio energetico

AUTONOMIA E BATTERIE

Standard: 1h o 3h, Ni-Cd 3,6V batteria
Premium: 1h o 3h, LiFePO₄ 6,4V batteria

CLASSE

II o III

GRADO IP & IK

IP40, IK08

DISTANZA DI VISIBILITA'

30 m

TIPOLOGIA

Singola faccia

TEMPERATURA

Autonoma: t_a: 0°C ÷ 40°C
Central battery: t_a: 0°C ÷ 50°C

OPZIONI

SE – solo emergenza • SA – sempre accesa • AT – autotest • PT – pulsante di test
• CB – central battery • Versioni central test RUBIC o alimentazione e controllo centralizzato *

INFORMAZIONI

LED indicazione stato alimentazione e ricarica batteria • Protezione contro scarica profonda
• Classe di isolamento III per versione FZLV e FZLV2 • ⁽¹⁾ Vedi kit per incasso nella sezione accessori • ⁽²⁾ 1pz di pittogramma universale è incluso in ogni confezione

* su richiesta

DIMENSIONI [mm]

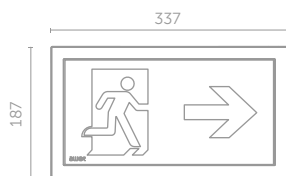

⁽²⁾ pittogramma

	CODICE ORDINE	INFINITY A PARETE		LISTINO
		IP40		
STANDARD	IF2BWS/1W/C/1/SA/X/WH	INFINITY II BW 1W LED STANDARD IP40 1h autonomia, SE + SA, colore Bianco		65,41 €
	IF2BWS/1W/C/3/SA/X/WH	INFINITY II BW 1W LED STANDARD IP40 3h autonomia, SE + SA, colore Bianco		68,71 €
	IF2BWS/2W/C/1/SA/X/WH	INFINITY II BW 2W LED STANDARD IP40 1h autonomia, SE + SA, colore Bianco		68,71 €
	IF2BWS/2W/C/3/SA/X/WH	INFINITY II BW 2W LED STANDARD IP40 3h autonomia, SE + SA, colore Bianco		73,46 €
PREMIUM CON AUTOTEST	IF2BWS/1W/B/1/SA/AT/WH	INFINITY II BW 1W LED PREMIUM IP40 1h autonomia, SE + SA, con AUTOTEST, colore Bianco		87,54 €
	IF2BWS/1W/B/3/SA/AT/WH	INFINITY II BW 1W LED PREMIUM IP40 3h autonomia, SE + SA, con AUTOTEST, colore Bianco		91,72 €
	IF2BWS/2W/B/1/SA/AT/WH	INFINITY II BW 2W LED PREMIUM IP40 1h autonomia, SE + SA, con AUTOTEST, colore Bianco		91,72 €
	IF2BWS/2W/B/3/SA/AT/WH	INFINITY II BW 2W LED PREMIUM IP40 3h autonomia, SE + SA, con AUTOTEST, colore Bianco		96,61 €
	IF2BWD/3W/B/1/SA/AT/WH	INFINITY II BW 3W con illuminazione downlight LED 80 lm PREMIUM IP40 1h autonomia, SE + SA, con AUTOTEST, colore Bianco		106,10 €
	IF2BWD/3W/B/3/SA/AT/WH	INFINITY II BW 3W con illuminazione downlight LED 80 lm PREMIUM IP40 3h autonomia, SE + SA, con AUTOTEST, colore Bianco		116,73 €
CENTRAL BATTERY	IF2BWS/1W/F/CB/X/WH	INFINITY II BW 1W LED IP40 per central battery system, colore Bianco		87,54 €
	IF2BWS/2W/F/CB/X/WH	INFINITY II BW 2W LED IP40 per central battery system, colore Bianco		91,72 €
	IF2BWD/3W/F/CB/X/WH	INFINITY II BW con illuminazione downlight LED 80 lm IP40 per central battery system, colore Bianco		106,10 €
ACCESSORI	IF2/REC	Kit per installazione in controsoffitto per lampada INFINITY		10,63 €
	IF2/RWC	Box per incasso filo muro per lampada INFINITY		51,52 €

LEGGENDA:

SE	Emergenza	E	Apparecchio autonomo con elettronica tipo STANDARD
SA	Emergenza + SA	C	Apparecchio autonomo con elettronica tipo STANDARD
AT	autotest	B	Apparecchio autonomo con elettronica tipo PREMIUM
CB	central battery	F	Apparecchio NON AUTONOMO - Alimentazione centralizzata



INFINITY II AC



AC
220-240V
50-60Hz

DC
176-275V

DC
24V

DC
48V

LED

IP40

IK08



d=30mm



Ni-Cd



LiFePO₄



KM 618355
BS-EN 60598-2-22



MATERIALI

Corpo Bianco, Grigio o Nero in policarbonato • Plexiglass

MONTAGGI

Superficie • Incasso ⁽¹⁾

ALIMENTAZIONE

Autonoma – 220 - 240VAC/50 - 60Hz
Central battery – 220 - 240VAC/50 - 60Hz; 176 - 275VDC
Central battery FZLV II – 48VDC *
Central battery FZLV – 24VDC *

SORGENTE

1W, 2W LED

RICARICA

Standard: max. 24h

Premium: max. 12h; charger a risparmio energetico

AUTONOMIA E BATTERIE

Standard: 1h o 3h, Ni-Cd 3,6V batteria

Premium: 1h o 3h, LiFePO₄ 6,4V batteria

CLASSE

II o III

GRADO IP & IK

IP40, IK08

DISTANZA DI VISIBILITA'

30 m

TIPOLOGIA

Doppia faccia

TEMPERATURA

Autonoma: t_a: 0°C ÷ 40°C

Central battery: t_a: 0°C ÷ 50°C

OPZIONI

SE – solo emergenza • SA – sempre accesa • AT – autotest • PT – pulsante di test
• CB – central battery • Versioni central test RUBIC o alimentazione e controllo centralizzato *

INFORMAZIONI

LED indicazione stato alimentazione e ricarica batteria • Protezione contro scarica profonda
• Classe di isolamento III per versione FZLV e FZLV2 • ⁽¹⁾ Vedi kit per incasso nella sezione accessori • ⁽²⁾ 1pz di pittogramma universale è incluso in ogni confezione

* su richiesta

DIMENSIONI [mm]

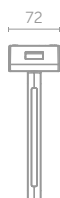
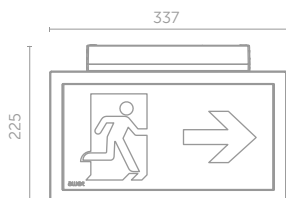

⁽²⁾ pittogramma

	CODICE ORDINE	INFINITY A SOFFITTO		LISTINO
		IP40		
STANDARD	IF2ACS/1W/C/1/SA/X/WH	INFINITY II AC 1W LED STANDARD IP40 1h autonomia, SE + SA, colore Bianco		72,59 €
	IF2ACS/1W/C/3/SA/X/WH	INFINITY II AC 1W LED STANDARD IP40 3h autonomia, SE + SA with manual test button, colore Bianco		78,78 €
	IF2ACS/1W/C/3/SA/X/WH	INFINITY II AC 1W LED STANDARD IP40 3h autonomia, SE + SA, colore Bianco		75,90 €
	IF2ACS/2W/C/1/SA/X/WH	INFINITY II AC 2W LED STANDARD IP40 1h autonomia, SE + SA, colore Bianco		75,90 €
	IF2ACS/2W/C/3/SA/X/WH	INFINITY II AC 2W LED STANDARD IP40 3h autonomia, SE + SA, colore Bianco		80,64 €
PREMIUM CON AUTOTEST	IF2ACD/3W/B/1/SA/AT/WH	INFINITY II AC 3W con illuminazione downlight 1W LED 80 lm PREMIUM IP40 1h autonomia, SE + SA, con AUTOTEST, colore Bianco		113,29 €
	IF2ACD/3W/B/3/SA/AT/WH	INFINITY II AC 3W con illuminazione downlight 1W LED 80 lm PREMIUM IP40 3h autonomia, SE + SA, con AUTOTEST, colore Bianco		123,92 €
	IF2ACS/1W/B/1/SA/AT/WH	INFINITY II AC 1W LED PREMIUM IP40 1h autonomia, SE + SA, con AUTOTEST, colore Bianco		94,73 €
	IF2ACS/1W/B/3/SA/AT/WH	INFINITY II AC 1W LED PREMIUM IP40 3h autonomia, SE + SA, con AUTOTEST, colore Bianco		98,91 €
	IF2ACS/2W/B/1/SA/AT/WH	INFINITY II AC 2W LED PREMIUM IP40 1h autonomia, SE + SA, con AUTOTEST, colore Bianco		98,91 €
	IF2ACS/2W/B/3/SA/AT/WH	INFINITY II AC 2W LED PREMIUM IP40 3h autonomia, SE + SA, con AUTOTEST, colore Bianco		103,80 €
CENTRAL BATTERY	IF2ACS/1W/F/CB/X/WH	INFINITY II AC 1W LED IP40 per central battery system, colore Bianco		94,73 €
	IF2ACS/2W/F/CB/X/WH	INFINITY II AC 2W LED IP40 per central battery system, colore Bianco		98,90 €
	IF2ACD/3W/F/CB/X/WH	INFINITY II AC downlight illumination 3W LED 80 lm IP40 per central battery system, colore Bianco		113,29 €

LEGGENDA:

SE	Emergenza	E	Apparecchio autonomo con elettronica tipo STANDARD
SA	Emergenza + SA	C	Apparecchio autonomo con elettronica tipo STANDARD
AT	autotest	B	Apparecchio autonomo con elettronica tipo PREMIUM
CB	central battery	F	Apparecchio NON AUTONOMO - Alimentazione centralizzata

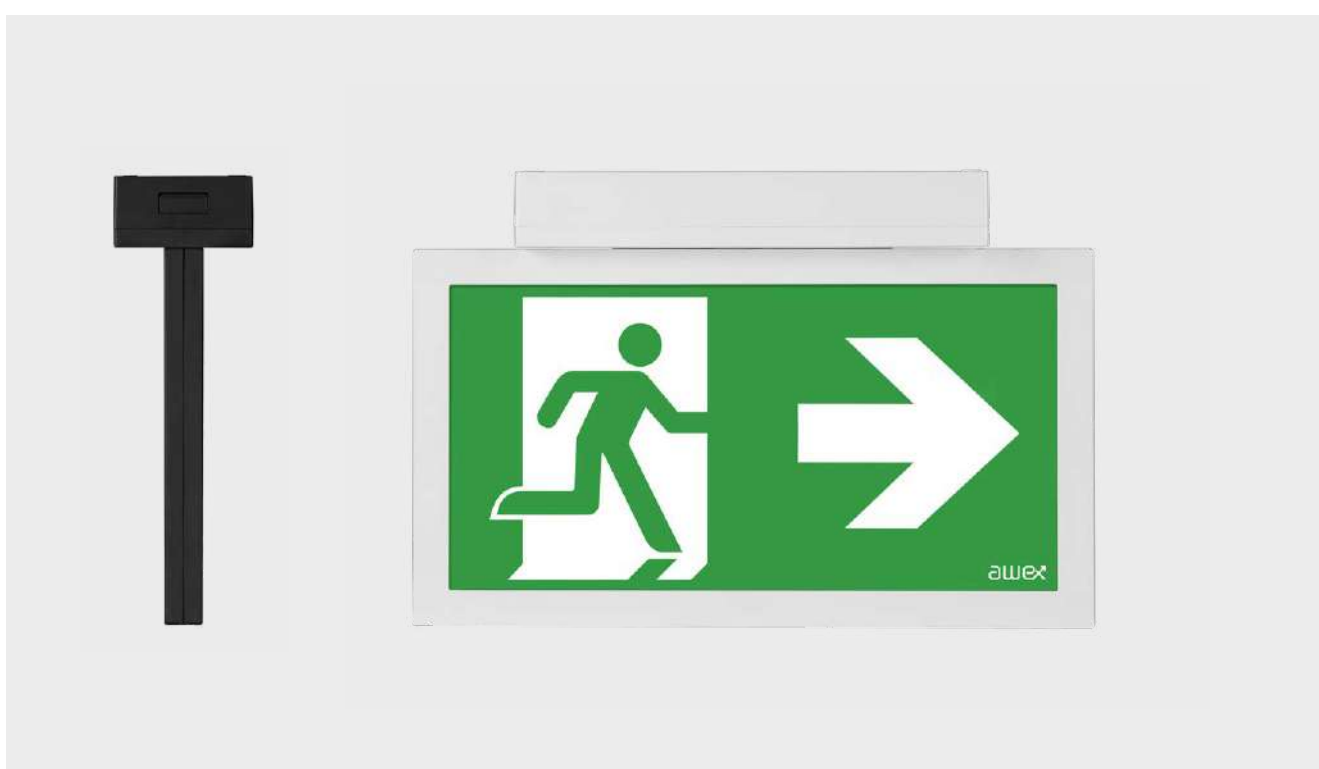

INFINITY II AW



AC
220-240V
50-60Hz

DC
176-275V

DC
24V

DC
48V

LED

IP40

IK08



d=30m



KM 618355
BS-EN 60598-2-22



MATERIALI

Corpo Bianco, Grigio o Nero in policarbonato • Plexiglass

MONTAGGI

Superficie • Incasso ⁽¹⁾

ALIMENTAZIONE

Autonoma – 220 - 240VAC/50 - 60Hz
Central battery – 220 - 240VAC/50 - 60Hz; 176 - 275VDC
Central battery FZLV II – 48VDC *
Central battery FZLV – 24VDC *

SORGENTE

1W, 2W LED

RICARICA

Standard: max. 24h
Premium: max. 12h; charger a risparmio energetico

AUTONOMIA E BATTERIE

Standard: 1h o 3h, Ni-Cd 3,6V batteria
Premium: 1h o 3h, LiFePO₄ 6,4V batteria

CLASSE

II o III

GRADO IP & IK

IP40, IK08

DISTANZA DI VISIBILITA'

30 m

TIPOLOGIA

Doppia faccia

TEMPERATURA

Autonoma: t_a: 0°C ÷ 40°C
Central battery: t_a: 0°C ÷ 50°C

OPZIONI

SE – solo emergenza • SA – sempre accesa • AT – autotest • PT – pulsante di test
• CB – central battery • Versioni central test RUBIC o alimentazione e controllo centralizzato *

INFORMAZIONI

LED indicazione stato alimentazione e ricarica batteria • Protezione contro scarica profonda
• Classe di isolamento III per versione FZLV e FZLV2 • ⁽¹⁾ Vedi kit per incasso nella sezione accessori • ⁽²⁾ 1pz di pittogramma universale è incluso in ogni confezione

* su richiesta

DIMENSIONI [mm]

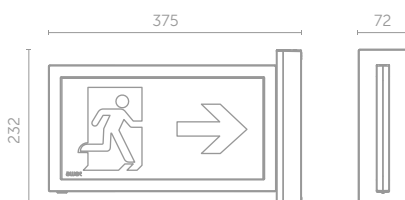

⁽²⁾ pittogramma

	CODICE ORDINE	INFINITY A BANDIERA		LISTINO
		IP40		
STANDARD	IF2AWS/1W/C/1/SA/X/WH	INFINITY II AW 1W LED STANDARD IP40 1h autonomia, SE + SA, colore Bianco		72,59 €
	IF2AWS/1W/C/3/SA/X/WH	INFINITY II AW 1W LED STANDARD IP40 3h autonomia, SE + SA, colore Bianco		75,90 €
	IF2AWS/2W/C/1/SA/X/WH	INFINITY II AW 2W LED STANDARD IP40 1h autonomia, SE + SA, colore Bianco		75,90 €
	IF2AWS/2W/C/3/SA/X/WH	INFINITY II AW 2W LED STANDARD IP40 3h autonomia, SE + SA, colore Bianco		80,67 €
PREMIUM CON AUTOTEST	IF2AWS/1W/B/1/SA/AT/WH	INFINITY II AW 1W LED PREMIUM IP40 1h autonomia, SE + SA, con AUTOTEST, colore Bianco		94,73 €
	IF2AWS/1W/B/3/SA/AT/WH	INFINITY II AW 1W LED PREMIUM IP40 3h autonomia, SE + SA, con AUTOTEST, colore Bianco		98,91 €
	IF2AWS/2W/B/1/SA/AT/WH	INFINITY II AW 2W LED PREMIUM IP40 1h autonomia, SE + SA, con AUTOTEST, colore Bianco		98,91 €
	IF2AWS/2W/B/3/SA/AT/WH	INFINITY II AW 2W LED PREMIUM IP40 3h autonomia, SE + SA, con AUTOTEST, colore Bianco		103,80 €
	IF2AWD/3W/B/1/SA/AT/WH	INFINITY II AW Segnalazione + downlight 3W LED 80 lm PREMIUM IP40 1h autonomia, SE + SA, con AUTOTEST, colore Bianco		113,29 €
	IF2AWD/3W/B/3/SA/AT/WH	INFINITY II AW Segnalazione + downlight 3W LED 80 lm PREMIUM IP40 3h autonomia, SE + SA, con AUTOTEST, colore Bianco		123,92 €
CENTRAL BATTERY	IF2AWS/1W/F/CB/X/WH	INFINITY II AW 1W LED IP40 per central battery system, colore Bianco		94,73 €
	IF2AWS/2W/F/CB/X/WH	INFINITY II AW 2W LED IP40 per central battery system, colore Bianco		98,91 €

LEGGENDA:

SE	Emergenza	E	Apparecchio autonomo con elettronica tipo STANDARD
SA	Emergenza + SA	C	Apparecchio autonomo con elettronica tipo STANDARD
AT	autotest	B	Apparecchio autonomo con elettronica tipo PREMIUM
CB	central battery	F	Apparecchio NON AUTONOMO - Alimentazione centralizzata



INFINITY II AL



AC
220-240V
50-60Hz

DC
176-275V

DC
24V

DC
48V

LED

IP40

IK08



d=30m



Ni-Cd



LiFePO₄



KM 618355
BS-EN 60598-2-22



MATERIALI

Corpo Bianco, Grigio o Nero in policarbonato • Plexiglass

MONTAGGI

Superficie • Incasso ⁽¹⁾

ALIMENTAZIONE

Autonoma – 220 - 240VAC/50 - 60Hz
Central battery – 220 - 240VAC/50 - 60Hz; 176 - 275VDC
Central battery FZLV II – 48VDC *
Central battery FZLV – 24VDC *

SORGENTE

1W, 2W LED

RICARICA

Standard: max. 24h
Premium: max. 12h; charger a risparmio energetico

AUTONOMIA E BATTERIE

Standard: 1h o 3h, Ni-Cd 3,6V batteria
Premium: 1h o 3h, LiFePO₄ 6,4V batteria

CLASSE

II o III

GRADO IP & IK

IP40, IK08

DISTANZA DI VISIBILITA'

30 m

TIPOLOGIA

Doppia faccia

TEMPERATURA

Autonoma: t_a: 0°C ÷ 40°C
Central battery: t_a: 0°C ÷ 50°C

OPZIONI

SE – solo emergenza • SA – sempre accesa • AT – autotest • PT – pulsante di test
• CB – central battery • Versioni central test RUBIC o alimentazione e controllo centralizzato *

INFORMAZIONI

LED indicazione stato alimentazione e ricarica batteria • Protezione contro scarica profonda
• Classe di isolamento III per versione FZLV e FZLV2 • ⁽¹⁾ Vedi kit per incasso nella sezione accessori • ⁽²⁾ 1pz di pittogramma universale è incluso in ogni confezione

* su richiesta

DIMENSIONI [mm]

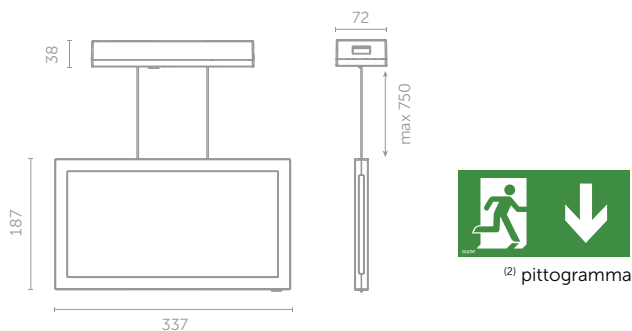

	CODICE ORDINE	INFINITY A SOSPENSIONE	LISTINO
		IP40	
STANDARD	IF2ALS/1W/C/1/SA/X/WH	INFINITY II AL 1W LED STANDARD IP40 1h autonomia, SE + SA, colore Bianco	74,03 €
	IF2ALS/1W/C/3/SA/X/WH	INFINITY II AL 1W LED STANDARD IP40 3h autonomia, SE + SA, colore Bianco	77,35 €
	IF2ALS/2W/C/1/SA/X/WH	INFINITY II AL 2W LED STANDARD IP40 1h autonomia, SE + SA, colore Bianco	77,35 €
	IF2ALS/2W/C/3/SA/X/WH	INFINITY II AL 2W LED STANDARD IP40 3h autonomia, SE + SA, colore Bianco	82,09 €
PREMIUM CON AUTOTEST	IF2ALS/1W/B/1/SA/AT/WH	INFINITY II AL 1W LED PREMIUM IP40 1h autonomia, SE + SA, con AUTOTEST, colore Bianco	96,19 €
	IF2ALS/1W/B/3/SA/AT/WH	INFINITY II AL 1W LED PREMIUM IP40 1h autonomia, SE + SA, con AUTOTEST, colore Bianco	100,34 €
	IF2ALS/2W/B/1/SA/AT/WH	INFINITY II AL 1W LED PREMIUM IP40 1h autonomia, SE + SA, con AUTOTEST, colore Bianco	100,34 €
	IF2ALS/2W/B/3/SA/AT/WH	INFINITY II AL 1W LED PREMIUM IP40 1h autonomia, SE + SA, con AUTOTEST, colore Bianco	105,23 €
	IF2ALD/3W/B/1/SA/AT/WH	INFINITY II AL 3W con illuminazione downlight 1W LED 80 lm LED PREMIUM IP40 1h autonomia, SE + SA, con AUTOTEST, colore Bianco	114,71 €
	IF2ALD/3W/B/3/SA/AT/WH	INFINITY II AL 3W con illuminazione downlight 1W LED 80 lm LED PREMIUM IP40 3h autonomia, SE + SA, con AUTOTEST, colore Bianco	125,35 €
CENTRAL BATTERY	IF2ALS/1W/F/CB/X/WH	INFINITY II AL 1W LED STANDARD IP40 1h autonomia, SE + SA, colore Bianco	96,17 €
	IF2ALS/2W/F/CB/X/WH	INFINITY II AL 2W LED STANDARD IP40 1h autonomia, SE + SA, colore Bianco	100,34 €
	IF2ALD/3W/F/CB/X/WH	INFINITY II AL 3W con illuminazione downlight 1W LED 80 lm IP40 per central battery system, colore Bianco	114,71 €

LEGGENDA:

SE	Emergenza	E	Apparecchio autonomo con elettronica tipo STANDARD
SA	Emergenza + SA	C	Apparecchio autonomo con elettronica tipo STANDARD
AT	autotest	B	Apparecchio autonomo con elettronica tipo PREMIUM
CB	central battery	F	Apparecchio NON AUTONOMO - Alimentazione centralizzata

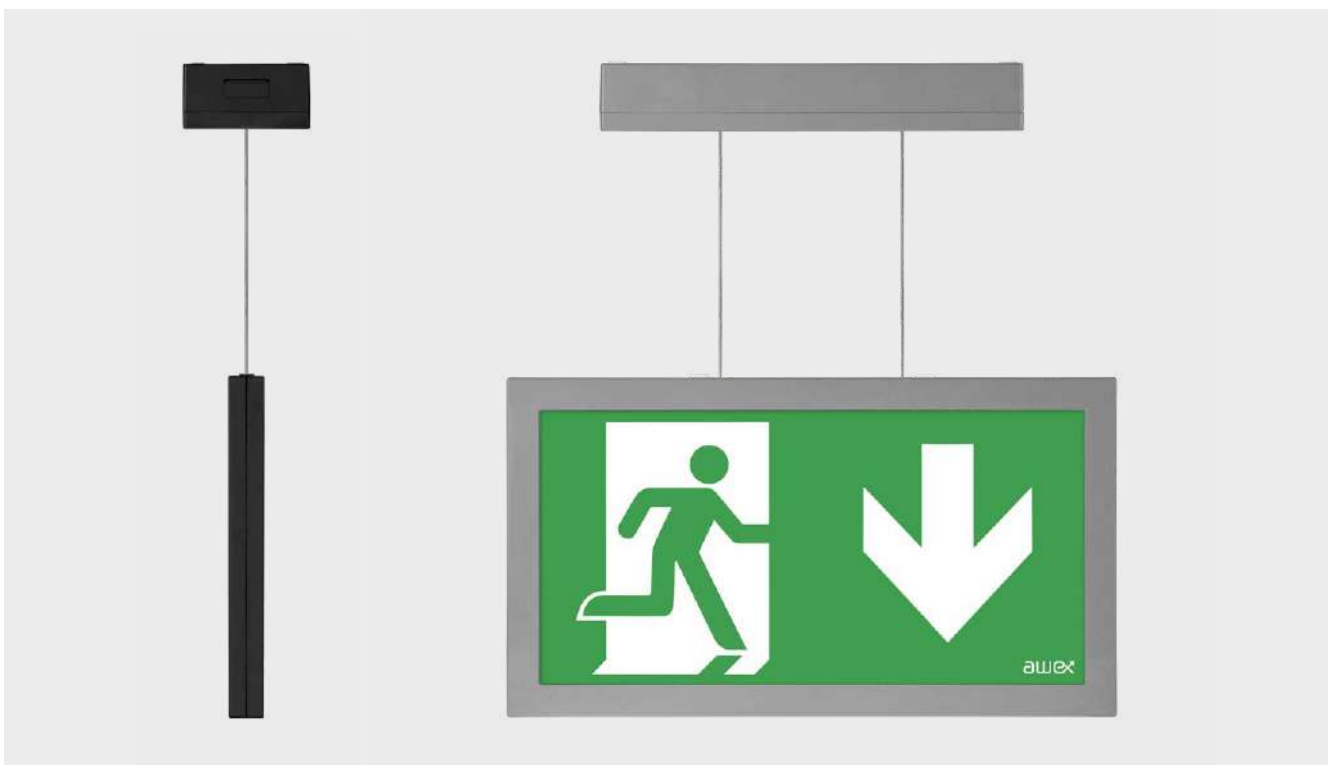

INFINITY II accessori



ACCESSORI PER INCASSO

CODICE: IF2/REC/WH
IF2/REC/GR
IF2/REC/BL

DIMENSIONI [mm]

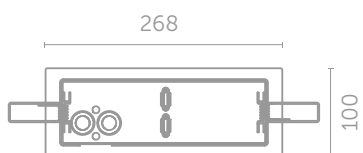

37



ADATTABILE A INFINITY B, AC, AL, AW



SCATOLA A MURO

CODICE: IF2/RWC
* RICHIEDE UN ACCESSORIO PER
INCASSO (IF2/REC)

DIMENSIONI [mm]

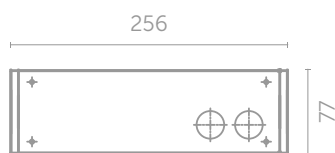

42



ADATTABILE A INFINITY B, AW



SK-8

AC
220-240V
50-60Hz

DC
176-275V

DC
24V

DC
48V

LED

IP44

IK08



d=30m



CE

Ni-Cd

LiFePO₄



KM 618355
BS-EN 60598-2-22



MATERIALI

Corpo Bianco in policarbonato • Cover opale in policarbonato con lenti

MONTAGGI

Superficie • Incasso ⁽¹⁾

ALIMENTAZIONE

Autonoma – 220 - 240VAC/50 - 60Hz
Central battery – 220 - 240VAC/50 - 60Hz; 176 - 275VDC
Central battery FZLV II – 48VDC *
Central battery FZLV – 24VDC *

SORGENTE

1W, 2W LED

RICARICA

Standard: max. 24h
Premium: max. 12h; charger a risparmio energetico

AUTONOMIA E BATTERIE

Standard: 1h o 3h, Ni-Cd 3,6V batteria
Premium: 1h o 3h, LiFePO₄ 6,4V batteria

CLASSE

II o III

GRADO IP & IK

IP44, IK08

DISTANZA DI VISIBILITA'

30 m

TIPOLOGIA

Doppia faccia

TEMPERATURA

Autonoma: t_a: 0°C ÷ 40°C
Central battery: t_a: 0°C ÷ 50°C

OPZIONI

SE – solo emergenza • SA – sempre accesa • AT – autotest • PT – pulsante di test
• CB – central battery • Versioni central test RUBIC o alimentazione e controllo centralizzato *

INFORMAZIONI

LED indicazione stato alimentazione e ricarica batteria • Protezione contro scarica profonda
• Classe di isolamento III per versione FZLV e FZLV2 • ⁽¹⁾ Vedi kit per incasso nella sezione accessori • ⁽²⁾ 1pz di pittogramma universale è incluso in ogni confezione

* su richiesta

DIMENSIONI [mm]

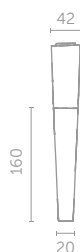
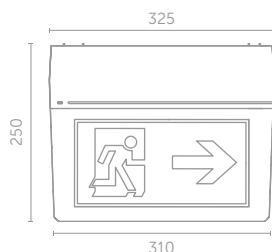

⁽²⁾ pittogramma

	CODICE ORDINE	SK-8	LISTINO	
		IP44		
STANDARD	SK-8/1W/C/1/SA/X/WL	SK-8 1W LED STANDARD IP44 1h autonomia, SE + SA colore bianco con plafoniera opale		56,49 €
	SK-8/1W/C/3/SA/X/WL	SK-8 1W LED STANDARD IP44 3h autonomia, SE + SA colore bianco con plafoniera opale		59,97 €
	SK-8/2W/C/1/SA/X/WL	SK-8 2W LED STANDARD IP44 1h autonomia, SE + SA colore bianco con plafoniera opale		61,20 €
	SK-8/2W/C/3/SA/X/WL	SK-8 2W LED STANDARD IP44 3h autonomia, SE + SA colore bianco con plafoniera opale		65,33 €
	SK-8/3W/C/1/SA/X/WT	SK-8 3W LED 100 lm STANDARD IP44 1h autonomia, SE + SA colore bianco con cover trasparente con lenti		65,78 €
	SK-8/3W/C/3/SA/X/WT	SK-8 3W LED 100 lm STANDARD IP44 3h autonomia, SE + SA colore bianco con cover trasparente con lenti		81,82 €
PREMIUM CON AUTOTEST	SK-8/1W/B/1/SA/AT/WL	SK-8 1W LED PREMIUM IP44 1h autonomia, SE + SA, con AUTOTEST colore bianco con plafoniera opale		77,63 €
	SK-8/1W/B/3/SA/AT/WL	SK-8 1W LED PREMIUM IP44 3h autonomia, SE + SA, con AUTOTEST colore bianco con plafoniera opale		82,23 €
	SK-8/2W/B/1/SA/AT/WL	SK-8 2W LED PREMIUM IP44 1h autonomia, SE + SA, con AUTOTEST colore bianco con plafoniera opale		82,23 €
	SK-8/2W/B/3/SA/AT/WL	SK-8 2W LED PREMIUM IP44 3h autonomia, SE + SA, con AUTOTEST colore bianco con plafoniera opale		98,30 €
	SK-8/3W/B/1/SA/AT/WT	SK-8 3W LED 120 lm PREMIUM IP44 1h autonomia, SE + SA, con AUTOTEST colore bianco con cover trasparente con lenti		85,11 €
	SK-8/3W/B/3/SA/AT/WT	SK-8 3W LED 120 lm PREMIUM IP44 3h autonomia, SE + SA, con AUTOTEST colore bianco con cover trasparente con lenti		101,20 €
CENTRAL BATTERY	SK-8/1W/F/CB/X/WL	SK-8 1W LED IP44 per central battery system colore bianco con plafoniera opale		77,63 €
	SK-8/2W/F/CB/X/WL	SK-8 2W LED IP44 per central battery system colore bianco con plafoniera opale		82,23 €
	SK-8/3W/F/CB/X/WT	SK-8 3W LED 120 lm IP44 per central battery system colore bianco con cover trasparente con lenti		85,11 €

LEGGENDA:

SE	Emergenza	E	Apparecchio autonomo con elettronica tipo STANDARD
SA	Emergenza + SA	C	Apparecchio autonomo con elettronica tipo STANDARD
AT	autotest	B	Apparecchio autonomo con elettronica tipo PREMIUM
CB	central battery	F	Apparecchio NON AUTONOMO - Alimentazione centralizzata



SK-8 accessori



**ACCESSORIO PER INCASSO IN
CONTROSOFFITTO**

CODICE: SK8/REC

DIMENSIONI [mm]

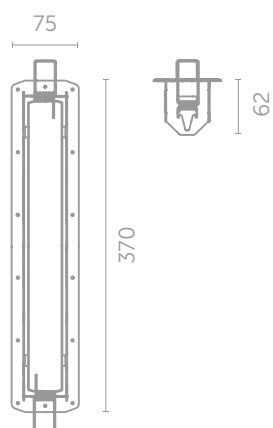

ADATTABILE A SK-8



ESCAPE ALU B



AC
220-240V
50-60Hz

DC
176-275V

DC
24V

DC
48V

LED

IP20

IK08

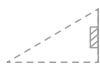

d=30m



CE

LiFePO₄

MATERIALI

Corpo in alluminio Bianco, Nero o grigio silver • Plexiglass

MONTAGGI

Superficie

ALIMENTAZIONE

Autonoma – 220 - 240VAC/50 - 60Hz
Central battery – 220 - 240VAC/50 - 60Hz; 176 - 275VDC
Central battery FZLV II – 48VDC *
Central battery FZLV – 24VDC *

SORGENTE

2W LED

RICARICA

max. 12h; charger a risparmio energetico

AUTONOMIA E BATTERIE

1h o 3h, LiFePO₄ 3,2V batteria

CLASSE

II o III

GRADO IP & IK

IP20, IK08

DISTANZA DI VISIBILITA'

30 m

TIPOLOGIA

Singola

TEMPERATURA

Autonoma: t_g: 0°C ÷ 40°C **Central battery:** t_g: 0°C ÷ 50°C

OPZIONI

SE – solo emergenza • SA – sempre accesa • PT – pulsante di test • AT – autotest
• CB – central battery • Versioni central test RUBIC o alimentazione e controllo centralizzato *

INFORMAZIONI

LED indicazione stato alimentazione e ricarica batteria • Protezione contro scarica profonda
• Classe di isolamento III per versione FZLV e FZLV2

* su richiesta

DIMENSIONI [mm]

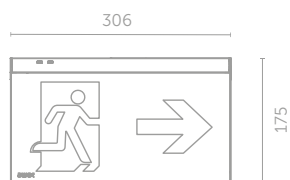

⁽¹⁾ pittogramma

	CODICE ORDINE	ESCAPE ALU B - PARETE	LISTINO
		IP20	
PREMIUM CON AUTOTEST	ESB/2W/B/1/SA/AT	ESCAPE ALU B 2W LED PREMIUM IP20 1h autonomia, SE + SA, con AUTOTEST, colore GRIGIO	158,75
	ESB/2W/B/1/SA/AT	ESCAPE ALU B 2W LED PREMIUM IP20 3h autonomia, SE + SA, con AUTOTEST, colore GRIGIO	163,75

LEGGENDA:

SE	Emergenza	E	Apparecchio autonomo con elettronica tipo STANDARD
SA	Emergenza + SA	C	Apparecchio autonomo con elettronica tipo STANDARD
AT	autotest	B	Apparecchio autonomo con elettronica tipo PREMIUM
CB	central battery	F	Apparecchio NON AUTONOMO - Alimentazione centralizzata



ESCAPE ALU AC



AC
220-240V
50-60Hz

DC
176-275V

DC
24V

DC
48V

LED

IP20

IK08



d=30m



CE

LiFePO₄

MATERIALI

Corpo in alluminio Bianco, Nero o grigio silver • Plexiglass

MONTAGGI

Superficie
Opzione da incasso ⁽¹⁾

ALIMENTAZIONE

Autonoma – 220 - 240VAC/50 - 60Hz
Central battery – 220 - 240VAC/50 - 60Hz; 176 - 275VDC
Central battery FZLV II – 48VDC *
Central battery FZLV – 24VDC *

SORGENTE

2W LED

RICARICA

max. 12h; charger a risparmio energetico

AUTONOMIA E BATTERIE

1h o 3h, LiFePO₄ 3,2V batteria

CLASSE

II o III

GRADO IP & IK

IP20, IK08

DISTANZA DI VISIBILITA'

30 m

TIPOLOGIA

Doppia faccia

TEMPERATURA

Autonoma: t_g: 0°C ÷ 40°C **Central battery:** t_g: 0°C ÷ 50°C

OPZIONI

SE – solo emergenza • SA – sempre accesa • PT – pulsante di test • AT – autotest
• CB – central battery • Versioni central test RUBIC o alimentazione e controllo centralizzato *

INFORMAZIONI

LED indicazione stato alimentazione e ricarica batteria • Protezione contro scarica profonda
• Classe di isolamento III per versione FZLV e FZLV2s • ⁽¹⁾ Vedi kit per incasso nella sezione accessori • ⁽²⁾ 1pz di pittogramma universale incluso in ogni confezione

* su richiesta

DIMENSIONI [mm]

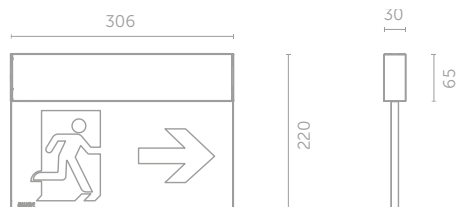

⁽²⁾ pittogramma

	CODICE ORDINE	ESCAPE ALU AC - SOFFITTO	LISTINO
		IP20	
PREMIUM CON AUTOTEST	ESAC/2W/B/1/SA/AT	ESCAPE ALU AC 2W LED PREMIUM IP20 1h autonomia, SE + SA, con AUTOTEST, colore GRIGIO	191,25
	EAC/2W/B/1/SA/AT	ESCAPE ALU AC 2W LED PREMIUM IP20 3h autonomia, SE + SA, con AUTOTEST, colore GRIGIO	196,25

LEGGENDA:

SE	Emergenza	E	Apparecchio autonomo con elettronica tipo STANDARD
SA	Emergenza + SA	C	Apparecchio autonomo con elettronica tipo STANDARD
AT	autotest	B	Apparecchio autonomo con elettronica tipo PREMIUM
CB	central battery	F	Apparecchio NON AUTONOMO - Alimentazione centralizzata



ESCAPE ALU AL

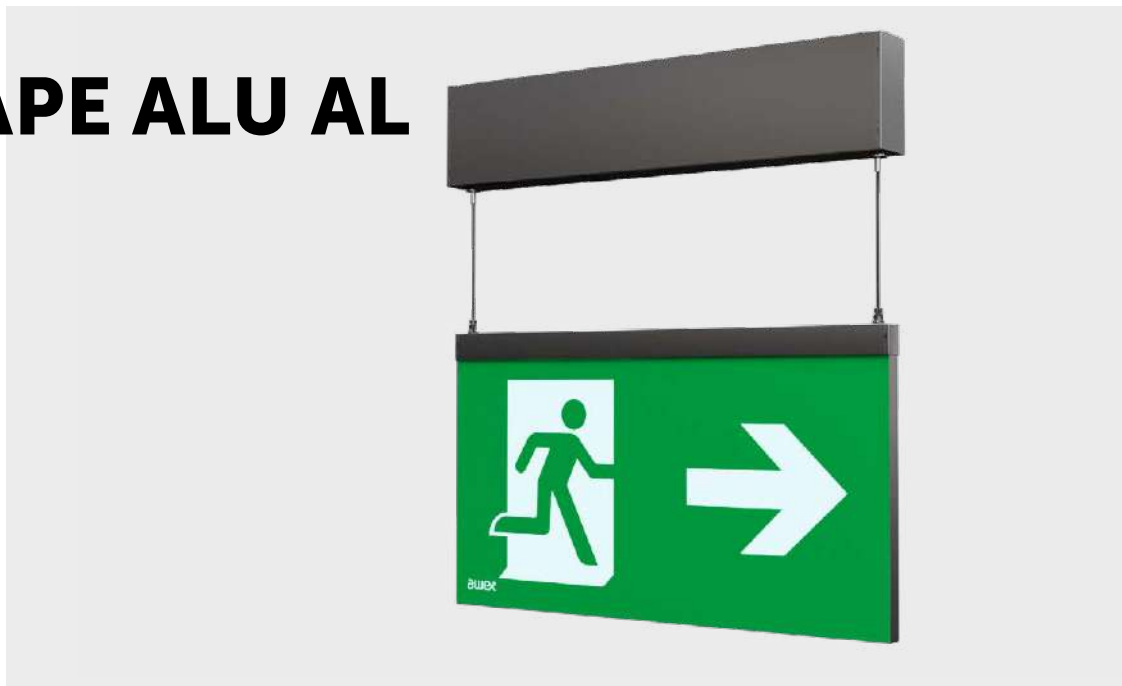

AC
220-240V
50-60Hz

DC
176-275V

DC
24V

DC
48V

LED

IP20

IK08

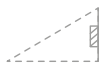

d=30m



MATERIALI

Corpo in alluminio Bianco, Nero o grigio silver • Plexiglass

MONTAGGI

Superficie
Opzione da incasso¹

ALIMENTAZIONE

Autonoma – 220 - 240VAC/50 - 60Hz
Central battery – 220 - 240VAC/50 - 60Hz; 176 - 275VDC
Central battery FZLV II – 48VDC *
Central battery FZLV – 24VDC *

SORGENTE

2W LED

RICARICA

max. 12h; charger a risparmio energetico

AUTONOMIA E BATTERIE

1h o 3h, LiFePO₄ 3,2V batteria

CLASSE

II o III

GRADO IP & IK

IP20, IK08

DISTANZA DI VISIBILITA'

30 m

TIPOLOGIA

Doppia faccia

TEMPERATURA

Autonoma: t_g: 0°C ÷ 40°C **Central battery:** t_g: 0°C ÷ 50°C

OPZIONI

SE – solo emergenza • SA – sempre accesa • PT – pulsante di test • AT – autotest
• CB – central battery • Versioni central test RUBIC o alimentazione e controllo centralizzato *

INFORMAZIONI

LED indicazione stato alimentazione e ricarica batteria • Protezione contro scarica profonda
• Classe di isolamento III per versione FZLV e FZLV2s • ⁽¹⁾ Vedi kit per incasso nella sezione accessori • ⁽²⁾ 1pz di pittogramma universale incluso in ogni confezione

* su richiesta

DIMENSIONI [mm]

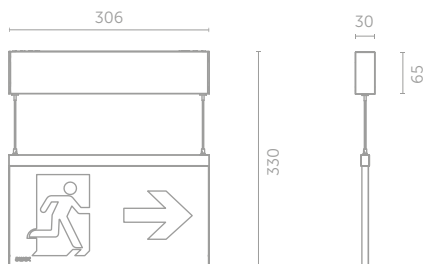

⁽²⁾ pittogramma

	CODICE ORDINE	ESCAPE ALU AL - SOSPENSIONE	LISTINO
		IP20	
PREMIUM CON AUTOTEST	ESAL/2W/B/1/SA/AT	ESCAPE ALU AL 2W LED PREMIUM IP20 1h autonomia, SE + SA, con AUTOTEST, colore GRIGIO	198,75
	ESAL/2W/B/1/SA/AT	ESCAPE ALU AL 2W LED PREMIUM IP20 3h autonomia, SE + SA, con AUTOTEST, colore GRIGIO	203,75

LEGGENDA:

SE	Emergenza	E	Apparecchio autonomo con elettronica tipo STANDARD
SA	Emergenza + SA	C	Apparecchio autonomo con elettronica tipo STANDARD
AT	autotest	B	Apparecchio autonomo con elettronica tipo PREMIUM
CB	central battery	F	Apparecchio NON AUTONOMO - Alimentazione centralizzata



ESCAPE ALU accessori



ACCESSORIO PER INCASSO NEL CONTROSOFFITTO

CODICE: ES/REC/WH

ES/REC/GR

ES/REC/BL

DIMENSIONI [mm]

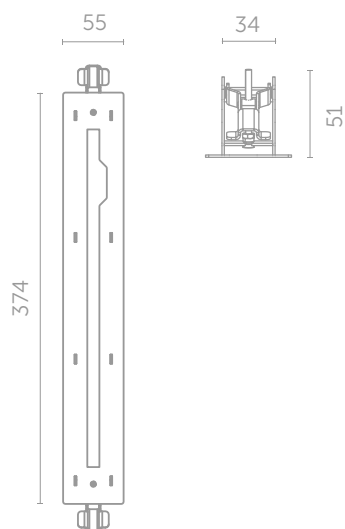

ADATTABILE A ESCAPE ALU (AL, AC)



TWINS



AC
220-240V
50-60Hz

DC
176-275V

DC
24V

DC
48V

LED

IP41

IK08



d=30m



KM 618355
BS-EN 60598-2-22



MATERIALI

Corpo colore argento o Nero in alluminio • Plexiglass

MONTAGGI

Superficie • A sospensione con corde ⁽¹⁾

ALIMENTAZIONE

Autonoma – 220 - 240VAC/50 - 60Hz
Central battery – 220 - 240VAC/50 - 60Hz; 176 - 275VDC
Central battery FZLV II – 48VDC *
Central battery FZLV – 24VDC *

SORGENTE

1W, 2W LED

RICARICA

Standard: max. 24h
Premium: max. 12h; charger a risparmio energetico

AUTONOMIA E BATTERIE

Standard: 1h o 3h, Ni-Cd 3,6V batteria
Premium: 1h o 3h, LiFePO₄ 6,4V batteria

CLASSE

I o III

GRADO IP & IK

IP41, IK08

DISTANZA DI VISIBILITA'

30 m

TIPOLOGIA

Doppia faccia

TEMPERATURA

Autonoma: t_a: 0°C ÷ 40°C
Central battery: t_a: 0°C ÷ 50°C

OPZIONI

SE – solo emergenza • SA – sempre accesa • PT – pulsante di test • AT – autotest
• CB – central battery • Versioni central test RUBIC o alimentazione e controllo centralizzato *

INFORMAZIONI

LED indicazione stato alimentazione e ricarica batteria • Protezione contro scarica profonda
• Classe di isolamento III per versione FZLV e FZLV2 • ⁽¹⁾ Vedi accessori sospensione con corde • ⁽²⁾ 1pz di pittogramma universale è incluso in ogni confezione

* su richiesta

DIMENSIONI [mm]

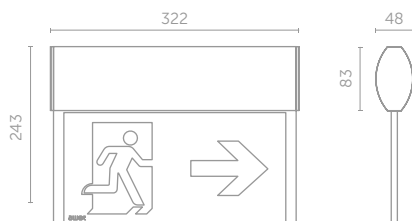

⁽²⁾ pittogramma

	CODICE ORDINE	TWINS	LISTINO
		IP41	
STANDARD	TW/1W/C/1/SA/X/SR	TWINS 1W LED STANDARD IP41 1h autonomia, SE + SA colore argento	55,75 €
	TW/1W/C/3/SA/X/SR	TWINS 1W LED STANDARD IP41 3h autonomia, SE + SA colore argento	57,10 €
	TW/1W/E/1/SE/X/SR	TWINS 1W LED STANDARD IP41 1h autonomia, solo Emergenza colore argento	51,03 €
	TW/2W/C/1/SA/X/SR	TWINS 2W LED STANDARD IP41 1h autonomia, SE + SA colore argento	62,93 €
	TW/2W/C/3/SA/X/SR	TWINS 2W LED STANDARD IP41 3h autonomia, SE + SA colore argento	65,72 €
PREMIUM CON AUTOTEST	TW/1W/B/1/SA/AT/SR	TWINS 1W LED PREMIUM IP41 1h autonomia, SE + SA, con AUTOTEST colore argento	76,13 €
	TW/1W/B/3/SA/AT/SR	TWINS 1W LED PREMIUM IP41 3h autonomia, SE + SA, con AUTOTEST colore argento	77,40 €
	TW/2W/B/1/SA/AT/SR	TWINS 2W LED PREMIUM IP41 1h autonomia, SE + SA, con AUTOTEST colore argento	83,32 €
	TW/2W/B/3/SA/AT/SR	TWINS 2W LED PREMIUM IP41 3h autonomia, SE + SA, con AUTOTEST colore argento	86,02 €
CENTRAL BATTERY	TW/1W/F/CB/X/SR	TWINS 1W LED IP41 per central battery system colore argento	76,13 €
	TW/2W/F/CB/X/SR	TWINS 2W LED IP41 per central battery system colore argento	83,32 €

LEGGENDA:

SE	Emergenza	E	Apparecchio autonomo con elettronica tipo STANDARD
SA	Emergenza + SA	C	Apparecchio autonomo con elettronica tipo STANDARD
AT	autotest	B	Apparecchio autonomo con elettronica tipo PREMIUM
CB	central battery	F	Apparecchio NON AUTONOMO - Alimentazione centralizzata



TWINS accessori



STAFFA ABANDIERA 90°

CODICE: 1009/SR
1009/BL

DIMENSIONI [mm]

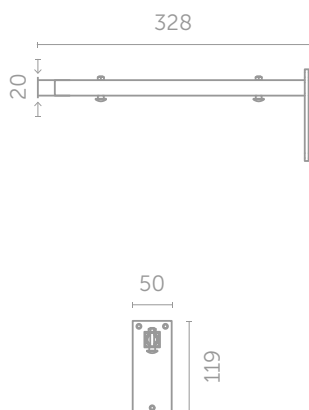

ADATTABILE A TWINS



CORDE PER SOSPENSIONE

CODICE: 1006/SR
1006/BL

DIMENSIONI [mm]



ADATTABILE A TWINS



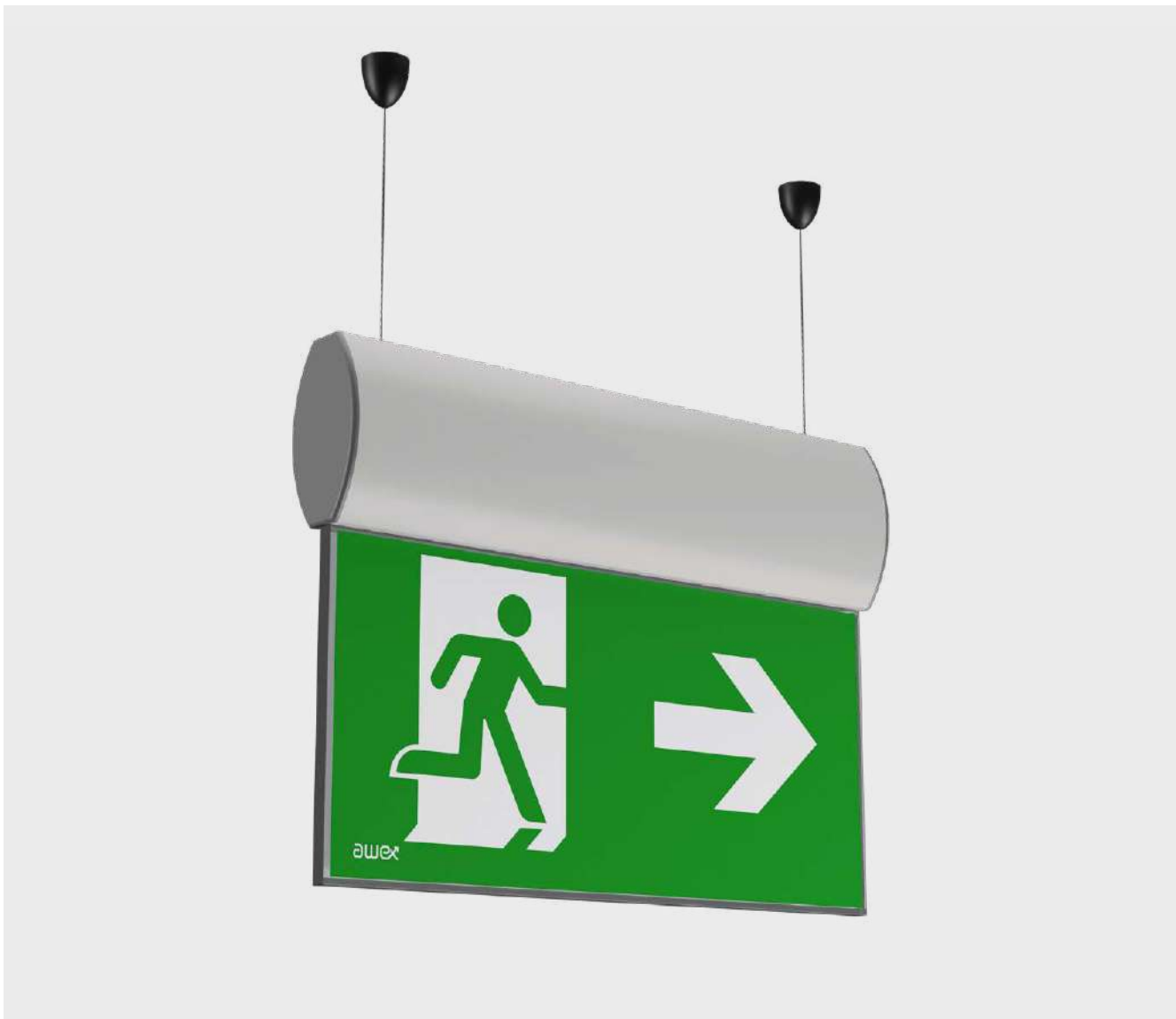

PLEXI LED



AC
220-240V
50-60Hz

DC
176-275V

DC
24V

DC
48V

LED

IP40

IK08



d=30m



Ni-Cd

LiFePO₄



KM 618355
BS-EN 60598-2-22



MATERIALI

Corpo Grigio o Bianco in acciaio • Plexiglass

MONTAGGI

Incasso

ALIMENTAZIONE

Autonoma – 220 - 240VAC/50 - 60Hz
Central battery – 220 - 240VAC/50 - 60Hz; 176 - 275VDC
Central battery FZLV II – 48VDC *
Central battery FZLV – 24VDC *

SORGENTE

1W, 2W LED

RICARICA

Standard: max. 24h
Premium: max. 12h; charger a risparmio energetico

AUTONOMIA E BATTERIE

Standard: 1h o 3h, Ni-Cd 3,6V batteria
Premium: 1h o 3h, LiFePO₄ 6,4V batteria

CLASSE

I o III

GRADO IP & IK

IP20, IK08

DISTANZA DI VISIBILITA'

30 m

TIPOLOGIA

Doppia faccia

TEMPERATURA

Autonoma: t_a: 0°C ÷ 40°C
Central battery: t_a: 0°C ÷ 50°C

OPZIONI

SE – solo emergenza • SA – sempre accesa • PT – pulsante di test • AT – autotest
• CB – central battery • Versioni central test RUBIC o alimentazione e controllo centralizzato *

INFORMAZIONI

LED indicazione stato alimentazione e ricarica batteria • Protezione contro scarica profonda
• Classe di isolamento III per versione FZLV e FZLV2 • ⁽¹⁾ 1pz di pittogramma universale è incluso in ogni confezione

* su richiesta

DIMENSIONI [mm]

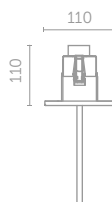
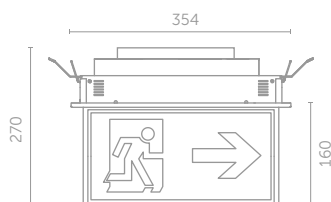

⁽¹⁾ pittogramma

	CODICE ORDINE	PLEXI LED	LISTINO
		IP20 INCASSO CONTROSOFFITTO	
STANDARD	PL/1W/C/1/SA/X/WH	PLEXI LED 1W LED STANDARD IP20 1h autonomia, SE+SA, colore Bianco	104,78 €
	PL/1W/C/3/SA/X/WH	PLEXI LED 1W LED STANDARD IP20 3h autonomia, SE+SA, colore Bianco	106,78 €
	PL/2W/C/1/SA/X/WH	PLEXI LED 2W LED STANDARD IP20 1h autonomia, SE+SA, colore Bianco	110,32 €
	PL/2W/C/3/SA/X/WH	PLEXI LED 2W LED STANDARD IP20 3h autonomia, SE+SA, colore Bianco	112,45 €
PREMIUM CON AUTOTEST	PL/1W/B/1/SA/AT/WH	PLEXI LED 1W LED PREMIUM IP20 1h autonomia, SE+SA, con AUTOTEST, colore Bianco	134,60 €
	PL/1W/B/3/SA/AT/WH	PLEXI LED 1W LED PREMIUM IP20 3h autonomia, SE+SA, con AUTOTEST, colore Bianco	137,86 €
	PL/2W/B/1/SA/AT/WH	PLEXI LED 2W LED PREMIUM IP20 1h autonomia, SE+SA, con AUTOTEST, colore Bianco	137,86 €
	PL/2W/B/3/SA/AT/WH	PLEXI LED 2W LED PREMIUM IP20 3h autonomia, SE+SA, con AUTOTEST, colore Bianco	140,12 €
CENTRAL BATTERY	PL/1W/F/X/CB/WH	PLEXI LED 1W LED PREMIUM IP20 per central battery system colore Bianco	168,19 €
	PL/2W/F/X/CB/WH	PLEXI LED 2W LED PREMIUM IP20 per central battery system colore Bianco	171,93 €

LEGGENDA:

SE	Emergenza	E	Apparecchio autonomo con elettronica tipo STANDARD
SA	Emergenza + SA	C	Apparecchio autonomo con elettronica tipo STANDARD
AT	autotest	B	Apparecchio autonomo con elettronica tipo PREMIUM
CB	central battery	F	Apparecchio NON AUTONOMO - Alimentazione centralizzata



CUBE



AC
220-240V
50-60Hz

DC
176-275V

DC
24V

DC
48V

LED

IP54



d=25m



CE



MATERIALI

Corpo bianco in acciaio • Cover opale in policarbonato

MONTAGGI

Superficie • Opzione kit a sospensione ⁽¹⁾

ALIMENTAZIONE

Autonoma – 220 - 240VAC/50 - 60Hz
Central battery – 220 - 240VAC/50 - 60Hz; 176 - 275VDC
Central battery FZLV II – 48VDC *
Central battery FZLV – 24VDC *

SORGENTE

3W, 6W LED

RICARICA

Premium: max. 12h; charger a risparmio energetico

AUTONOMIA E BATTERIE

Premium: 1h o 3h, LiFePO₄ 6,4V batteria

CLASSE

I o III

IP RATING

IP41

DISTANZA DI VISIBILITA'

25 m

TIPOLOGIA

Segnalazione su 4 lati

TEMPERATURA

Autonoma: t_a: 0°C ÷ 40°C
Central battery: t_a: -25°C ÷ 50°C

OPZIONI

SE – solo emergenza • SA – sempre accesa • PT – pulsante di test • AT – autotest
• CB – central battery • Versioni central test RUBIC o alimentazione e controllo centralizzato *

INFORMAZIONI

LED indicazione stato alimentazione e ricarica batteria • Protezione contro scarica profonda
• Classe di isolamento III per versione FZLV e FZLV2 • ⁽¹⁾ Vedi sezione accessori
• ⁽²⁾ n.4 pittogrammi universali forniti nella confezione

* su richiesta

DIMENSIONI [mm]

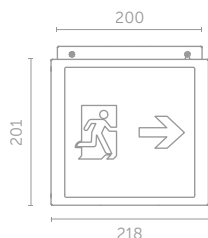
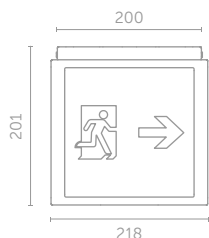

⁽²⁾ pittogramma

	CODICE ORDINE	CUBE	LISTINO
		SOFFITTO - PARETE	
STANDARD	CU/3W/C/1/SA/X/WH	CUBE 3W LED STANDARD IP41 1h autonomia, SE + SA	227,64 €
	CU/3W/C/3/SA/X/WH	CUBE 3W LED STANDARD IP41 3h autonomia, SE + SA	254,84 €
PREMIUM CON AUTOTEST	CU/3W/B/1/SA/AT	CUBE 3W LED PREMIUM IP41 1h autonomia, SE + SA, con AUTOTEST	280,83 €
	CU/3W/B/3/SA/AT	CUBE 3W LED PREMIUM IP41 3h autonomia, SE + SA, con AUTOTEST	319,55 €
CENTRAL BATTERY	CU/3W/F/CB/X	QUADRO 3x1W LED IP41 per central battery system	234,83 €

LEGGENDA:

SE	Emergenza	E	Apparecchio autonomo con elettronica tipo STANDARD
SA	Emergenza + SA	C	Apparecchio autonomo con elettronica tipo STANDARD
AT	autotest	B	Apparecchio autonomo con elettronica tipo PREMIUM
CB	central battery	F	Apparecchio NON AUTONOMO - Alimentazione centralizzata



CUBE 2 accessori



STAFFA A MURO

CODICE: CU2/AW

DIMENSIONI [mm]

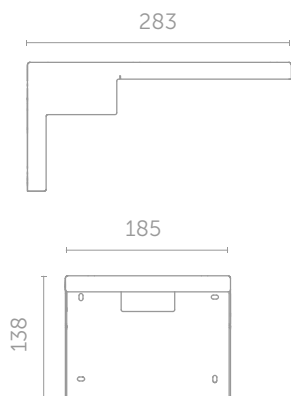

ADATTABILE A CUBE, CUBE L



ACCESSORIO PER MONTAGGIO A SOSPENSIONE

CODICE: CU2/PEN

DIMENSIONI [mm]

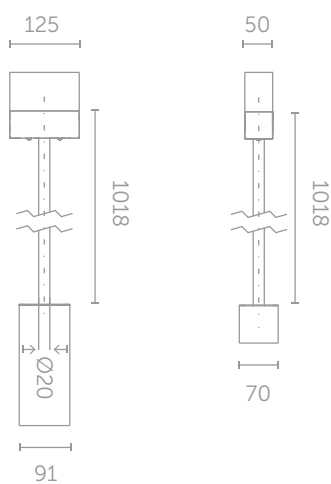

ADATTABILE A CUBE



CORDE PER MONTAGGIO A SOSPENSIONE (SET)

CODICE: 1016

DIMENSIONI [mm]

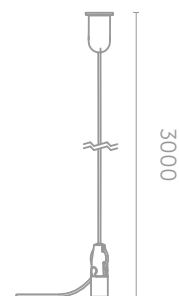

ADATTABILE A CUBE L



Pittogrammi

COME SCEGLIERE IL PITTOGRAMMA

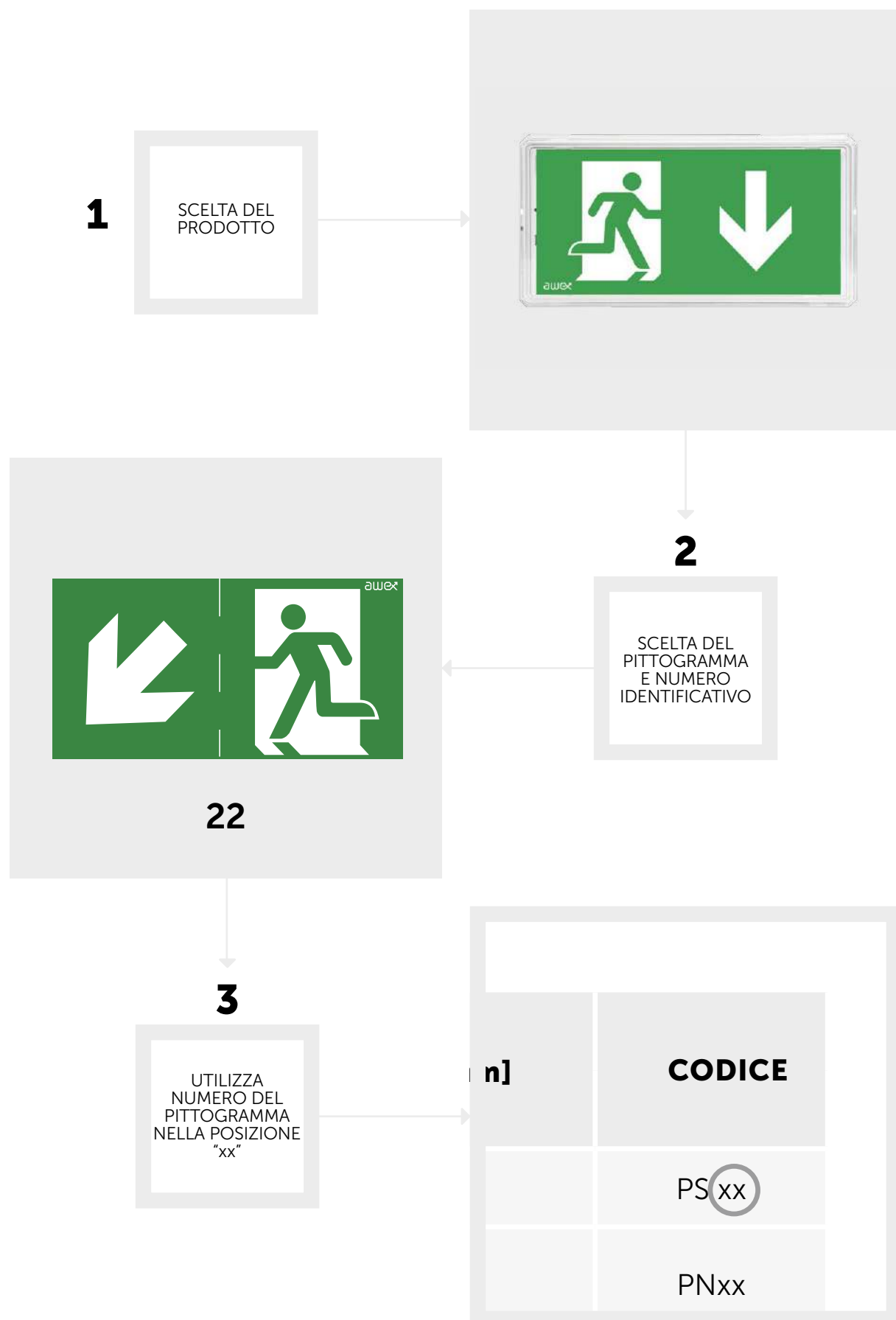

PITTOGRAMMI VERSATILI (CONFORMI ALLA EN ISO 7010:2012)

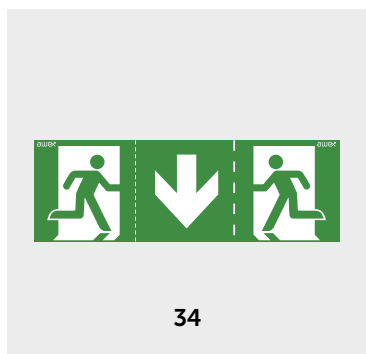
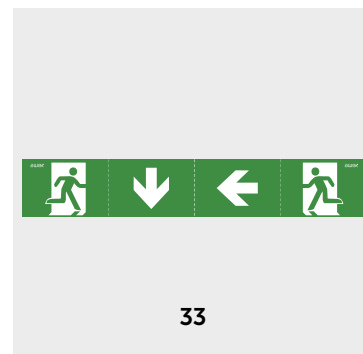
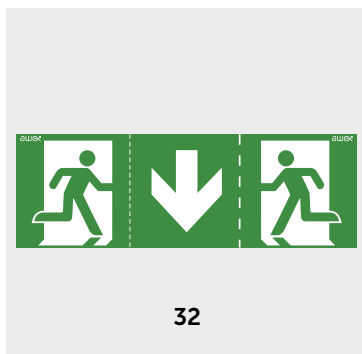
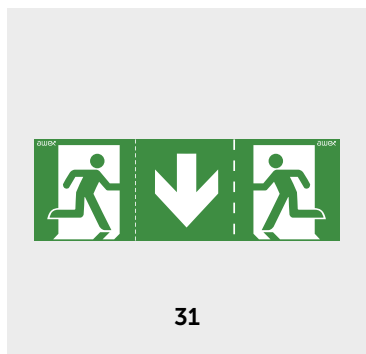

ADATTABILE A		DIMENSIONI [mm]	CODICE
FAMIGLIA PRODOTTO	CODICE		
EXIT M	ETE	125x250 (125x375)	PUxx
HELIOS LED	HL, HEL, HDL, HDEL		
ARROW	ARN, ARP)		
TWINS	TW	150x300 (150x450)	
INFINITY II	IF2B, IF2AC, IF2AW, IF2AL		
SK-8	SK-8		
EXIT L	ETL	100x300 (150x600)	
TIGER LED	TL, TSL	100x200 (100x300)	
EXIT S	ETS		
WONDER	WNDO, WNDP		

FRECCE (CONFORMI ALLA EN ISO 7010:2012)

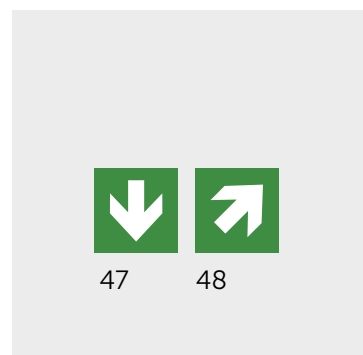
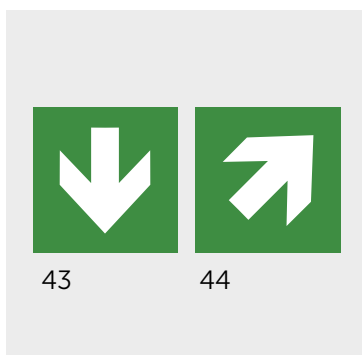
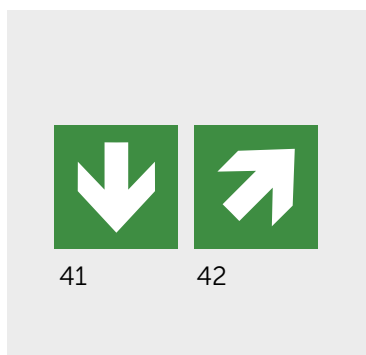

ADATTABILE A		DIMENSIONI [mm]	CODICE
FAMIGLIA PRODOTTO	CODICE		
EXIT M	ETE	125x125	PUxx
HELIOS LED	HL, HEL, HDL, HDEL		
ARROW	ARN, ARP)		
TWINS	TW	150x150	
INFINITY II	IF2B, IF2AC, IF2AW, IF2AL		
SK-8	SK-8		
EXIT L	ETL	100x100	
EXIT S	ETS		

KIT EMERGENZA LAMPADE LED-FLUO

	CODICE ORDINE	KIT EMERGENZA PER LAMPADE LED	LISTINO
		UMC	
STANDARD -AUTOTEST	UMC/4/1/PT	UMC standard 4W 1h . NiCd 4,8V 1500mAh	51,36 €
	UMC/4/3/PT	UMC standard 4W 3h - NiCd 4,8V 4000mAh	64,07 €
	UMC/4/1/AT	UMC premium 4W 1h - LiFePO4 6,4V 1000mAh	56,88 €
	UMC/4/3/AT	UMC premium 4W 3h LiFePO4 6,4V 3000mAh	70,76 €

	CODICE ORDINE	KIT EMERGENZA PER LAMPADE FLUORESCENTI	LISTINO
		NX	
STANDARD-AUTOTEST	NX/36/1	Kit emergenza NEXT 6 - 36W 1h autonomia	33,61 €
	NX/36/1/AT	Kit emergenza NEXT AUTOTEST 6 - 36W 1h autonomia	46,92 €
	NX/36/3	Kit emergenza NEXT 6 - 36W 3h autonomia	42,07 €
	NX/36/3/AT	Kit emergenza NEXT AUTOTEST 6 - 36W 3h autonomia	57,27 €
	NX/58/1	Kit emergenza NEXT 6 - 58W 1h autonomia	39,15 €
	NX/58/1/AT	Kit emergenza NEXT AUTOTEST 6 - 58W 1h autonomia	50,37 €
	NX/58/3	Kit emergenza NEXT 6 - 58W 3h autonomia	46,26 €
	NX/58/3/AT	Kit emergenza NEXT AUTOTEST 6 - 58W 3h autonomia	63,07 €
	NX/80/1	Kit emergenza NEXT 6 - 80W 1h autonomia	42,07 €
	NX/80/1/AT	Kit emergenza NEXT AUTOTEST 6 - 80W 1h autonomia	53,13 €
	NX/80/3	Kit emergenza NEXT 6 - 80W 3h autonomia	51,28 €
	NX/80/3/AT	Kit emergenza NEXT AUTOTEST 6 - 80W 3h autonomia	69,01 €

ACCESSORI

	CODICE ORDINE	ACCESSORI	LISTINO
ACCESSORI E PARTI DI RICAMBIO	LIFEPO4/6,4/1000	batteria LIFEPO4 6,4V 1000mAh	19,61 €
	LIFEPO4/6,4/1500	batteria LIFEPO4 6,4V 1500mAh	21,57 €
	LIFEPO4/6,4/3000	batteria LIFEPO4 6,4V 3000mAh	47,35 €
	LIFEPO4/9,6/1500	batteria LIFEPO4 9,6V 1500mAh	32,34 €
	NICD/3,6/1000	batteria NICD 3,6V 1000mAh	8,68 €
	NICD/3,6/1500	batteria NICD 3,6V 1500mAh	13,27 €
	NICD/3,6/2500	batteria NICD 3,6V 2500mAh	19,42 €
	NICD/3,6/4000	batteria NICD 3,6V 4000mAh	28,10 €
	NICD/4,8/1500	batteria NICD 4,8V 1500mAh	16,27 €
	NICD/4,8/2500	batteria NICD 4,8V 2500mAh	24,56 €
	NICD/4,8/4000	batteria NICD 4,8V 4000mAh	35,33 €
	NICD/6,0/1500	batteria NICD 6,0V 1500mAh	22,34 €
	NICD/6,0/2500	batteria NICD 6,0V 2500mAh	33,34 €
	NICD/6,0/4000	batteria NICD 6,0V 4000mAh	43,64 €
	NIMH/3,6/1500	batteria NIMH 3,6V 1500mAh	15,85 €
	NIMH/3,6/2500	batteria NIMH 3,6V 2500mAh	24,63 €
	NIMH/3,6/4000	batteria NIMH 3,6V 4000mAh	37,59 €
	NIMH/4,8/1500	batteria NIMH 4,8V 1500mAh	20,84 €
	NIMH/4,8/2500	batteria NIMH 4,8V 2500mAh	32,38 €
	NIMH/4,8/4000	batteria NIMH 4,8V 4000mAh	49,30 €
	NIMH/6,0/1500	batteria NIMH 6,0V 1500mAh	25,82 €
	NIMH/6,0/2500	batteria NIMH 6,0V 2500mAh	40,14 €
	NIMH/6,0/4000	batteria NIMH 6,0V 4000mAh	61,82 €
	PB22	Pittogramma B (150 x 300 mm) No. 22	0,92 €
	PB22F	Pittogramma B (150 x 300 mm) No. 22	3,45 €
	PB23	Pittogramma B (150 x 300 mm) No. 23	0,92 €
	PB23F	Pittogramma B (150 x 300 mm) No. 23	3,45 €
	PB24	Pittogramma B (150 x 300 mm) No. 24	0,92 €
	PB24F	Pittogramma B (150 x 300 mm) No. 24	3,45 €
	PB25	Pittogramma B (150 x 300 mm) No. 25	0,92 €
PB25F	Pittogramma B (150 x 300 mm) No. 25	3,45 €	
PB26	Pittogramma B (150 x 300 mm) No. 26	0,92 €	
PB26F	Pittogramma B (150 x 300 mm) No. 26	3,45 €	
PB27	Pittogramma B (150 x 300 mm) No. 27	0,92 €	
PB27F	Pittogramma B (150 x 300 mm) No. 27	3,45 €	

	CODICE ORDINE	ACCESSORI	LISTINO
	PB28	Pittogramma B (150 x 300 mm) No. 28	0,92 €
	PB28F	Pittogramma B (150 x 300 mm) No. 28	3,45 €
	PB29	Pittogramma B (150 x 300 mm) No. 29	0,92 €
	PB29F	Pittogramma B (150 x 300 mm) No. 29	3,45 €
	PB61	Pittogramma B (150 x 300 mm) No. 61	0,92 €
	PB61F	Pittogramma B (150 x 300 mm) No. 61	3,45 €
	PD22	Schermo serigrafato No. 22	18,69 €
	PD23	Schermo serigrafato No. 23	18,69 €
	PD24	Schermo serigrafato No. 24	18,69 €
	PD25	Schermo serigrafato No. 25	18,69 €
	PD26	Schermo serigrafato No. 26	18,69 €
	PD27	Schermo serigrafato No. 27	18,69 €
	PD28	Schermo serigrafato No. 28	18,69 €
	PD29	Schermo serigrafato No. 29	18,69 €
	PD61	Schermo serigrafato No. 61	18,69 €
	PM22	Pittogramma M (125 x 250 mm) No. 22	0,92 €
	PM23	Pittogramma M (125 x 250 mm) No. 23	0,92 €
	PM24	Pittogramma M (125 x 250 mm) No. 24	0,92 €
	PM25	Pittogramma M (125 x 250 mm) No. 25	0,92 €
	PM26	Pittogramma M (125 x 250 mm) No. 26	0,92 €
	PM27	Pittogramma M (125 x 250 mm) No. 27	0,92 €
	PM28	Pittogramma M (125 x 250 mm) No. 28	0,92 €
	PM29	Pittogramma M (125 x 250 mm) No. 29	0,92 €
	PM61	Pittogramma M (125 x 250 mm) No. 61	0,92 €
	PS22	Pittogramma S (100 x 300 mm) No. 22	0,92 €
	PS22F	Pittogramma M (125 x 250 mm) No. 22	3,45 €
	PS23	Pittogramma S (100 x 300 mm) No. 23	0,92 €
	PS23F	Pittogramma M (125 x 250 mm) No. 23	3,45 €
	PS24	Pittogramma S (100 x 300 mm) No. 24	0,92 €
	PS24F	Pittogramma M (125 x 250 mm) No. 24	3,45 €
	PS25	Pittogramma S (100 x 300 mm) No. 25	0,92 €
	PS25F	Pittogramma M (125 x 250 mm) No. 25	3,45 €
	PS26	Pittogramma S (100 x 300 mm) No. 26	0,92 €
	PS26F	Pittogramma M (125 x 250 mm) No. 26	3,45 €
	PS27	Pittogramma S (100 x 300 mm) No. 27	0,92 €
	PS27F	Pittogramma M (125 x 250 mm) No. 27	3,45 €
	PS28	Pittogramma S (100 x 300 mm) No. 28	0,92 €
	PS28F	Pittogramma M (125 x 250 mm) No. 28	3,45 €
	PS29	Pittogramma S (100 x 300 mm) No. 29	0,92 €
	PS29F	Pittogramma M (125 x 250 mm) No. 29	3,45 €
	PS61	Pittogramma S (100 x 300 mm) No. 61	0,92 €
	PS61F	Pittogramma M (125 x 250 mm) No. 61	3,45 €
	PU31	Pittogramma universale 125x250 mm (dimensioni125x375mm) No. 31	1,84 €
	PU32	Pittogramma universale 150x300 mm (dimensioni 150x450mm) No. 32	1,84 €
	PU33	Pittogramma universale 100x300 mm (dimensioni100x600mm) No. 33	1,84 €
	PU41	Pittogramma universale 125x250 mm No. 41	0,92 €
	PU42	Pittogramma universale 125x250 mm No. 42	0,92 €
	PU43	Pittogramma universale 150x300 mm No. 43	0,92 €
	PU44	Pittogramma universale 150x300 mm No. 44	0,92 €
	PU45	Pittogramma universale 100x300 mm No. 45	0,92 €
	PU46	Pittogramma universale 100x300 mm No. 46	0,92 €
	PV22	Pittogramma V (200 x 400 mm) No. 22	5,75 €
	PV23	Pittogramma V (200 x 400 mm) No. 23	5,75 €
	PV24	Pittogramma V (200 x 400 mm) No. 24	5,75 €
	PV25	Pittogramma V (200 x 400 mm) No. 25	5,75 €
	PV26	Pittogramma V (200 x 400 mm) No. 26	5,75 €
	PV27	Pittogramma V (200 x 400 mm) No. 27	5,75 €
	PV28	Pittogramma V (200 x 400 mm) No. 28	5,75 €
	PV29	Pittogramma V (200 x 400 mm) No. 29	5,75 €
	PV61	Pittogramma V (200 x 400 mm) No. 61	5,75 €
	PW22	Pittogramma W (300 x 600 mm) No. 22	11,50 €
	PW23	Pittogramma W (300 x 600 mm) No. 23	11,50 €
	PW24	Pittogramma W (300 x 600 mm) No. 24	11,50 €
	PW25	Pittogramma W (300 x 600 mm) No. 25	11,50 €
	PW26	Pittogramma W (300 x 600 mm) No. 26	11,50 €
	PW27	Pittogramma W (300 x 600 mm) No. 27	11,50 €
	PW28	Pittogramma W (300 x 600 mm) No. 28	11,50 €
	PW29	Pittogramma W (300 x 600 mm) No. 29	11,50 €
	PW61	Pittogramma W (300 x 600 mm) No. 61	11,50 €
	SK8/REC	Kit incasso per SK8	43,13 €
	UM/BOX	Scatola per Kit emergenza UM	15,81 €

ACCESSORI E PARTI DI RICAMBIO

CENTRAL BATTERY SYSTEM



FZLV II



CENTRAL BATTERY SYSTEM 48V

SPS



CENTRAL BATTERY SYSTEM
AC/AC

RUBIC UNA



CENTRAL TEST

CODICE ORDINE	SISTEMI CENTRALIZZATI SPS - 230VAC	LISTINO
SPS-300	Sistema SPS 300, Potenza 300W equipaggiato con 6 circuiti SE/SA e n.2 batterie da 26Ah	2 365,20 €
SPS-600	Sistema SPS 600, Potenza 600W equipaggiato con 6 circuiti SE/SA e n.2 batterie da 55Ah	3 294,56 €
SPS-1000	Sistema SPS 1000, Potenza 1000W equipaggiato con 12 circuiti SE/SA e n.2 batterie da 80Ah	4 636,17 €
SPS-1500	Sistema SPS 1500, Potenza 1500W equipaggiato con 12 circuiti SE/SA e n.2 batterie da 120Ah	5 897,84 €
SPS-2000	Sistema SPS 2000, Potenza 2000W equipaggiato con 12 circuiti SE/SA e n.2 batterie da 150Ah	7 048,23 €

CODICE ORDINE	SISTEMI CENTRALIZZATI BASSA TENSIONE 24-48VDC	LISTINO
	SISTEMI AD ALIMENTAZIONE CENTRALIZZATA 48V - FZLV2 *	
FZLV272A4S	SISTEMA FZLV2 (48vdc) standard cabinet, con 4 circuiti e batterie da 7,2Ah, Potenza 166W-1h o 64W-3h	3 134,00 €
FZLV272A4P	SISTEMA FZLV2 (48vdc) premium cabinet, con 4 circuiti e batterie da 7,2Ah, Potenza 166W-1h o 64W-3h	3 384,00 €
FZLV212A4S	SISTEMA FZLV2 (48vdc) standard cabinet, con 4 circuiti e batterie da 12Ah, Potenza 280W-1h o 110W-3h	3 324,67 €
FZLV212A8S	SISTEMA FZLV2 (48vdc) standard cabinet, con 8 circuiti e batterie da 12Ah, Potenza 280W-1h o 110W-3h	3 772,93 €
FZLV212A4P	SISTEMA FZLV2 (48vdc) premium cabinet, con 4 circuiti e batterie da 12Ah, Potenza 280W-1h o 110W-3h	3 674,67 €
FZLV212A8P	SISTEMA FZLV2 (48vdc) premium cabinet, con 8 circuiti e batterie da 12Ah, Potenza 280W-1h o 110W-3h	4 022,93 €
FZLV218A8S	SISTEMA FZLV2 (48vdc) standard cabinet, con 8 circuiti e batterie da 18Ah, Potenza 423W-1h o 168W-3h	4 643,00 €
FZLV226A8S	SISTEMA FZLV2 (48vdc) standard cabinet, con 8 circuiti e batterie da 26Ah, Potenza 600W-1h o 241W-3h	5 224,07 €
FZLV233A8S	SISTEMA FZLV2 (48vdc) standard cabinet, con 8 circuiti e batterie da 33Ah, Potenza 734W-1h o 309W-3h	5 688,40 €
FZLV240A8S	SISTEMA FZLV2 (48vdc) standard cabinet, con 8 circuiti e batterie da 40Ah, Potenza 890W-1h o 375W-3h	6 384,97 €
SISTEMI AD ALIMENTAZIONE CENTRALIZZATA 24V - FZLV *		
FZLV12Ah	SISTEMA FZLV (24vdc) cabinet con 4 circuiti e batterie da 12Ah, Potenza 123W-1h o 49W-3h	2 428,57 €
FZLV24Ah	SISTEMA FZLV (24vdc) cabinet con 4 circuiti e batterie da 24Ah, Potenza 219W-1h o 102W-3h	2 785,70 €
FZLV33Ah	SISTEMA FZLV (24vdc) cabinet con 4 circuiti e batterie da 33Ah, Potenza 263W-1h o 140W-3h	3 857,13 €
FZLV52Ah	SISTEMA FZLV (24vdc) cabinet con 4 circuiti e batterie da 52Ah, Potenza 304W-1h o 219W-3h	4 214,30 €

* Prezzi lampade indirizzabili per sistemi centralizzati a bassa tensione con sviluppo dimensionamento/progetto su richiesta

* Prezzi sistemi CBS230VDC e lampade indirizzabili con sviluppo del dimensionamento/progetto su richiesta

Per info contattare: infoawexitalia@awex.eu

Per info contattare: ufficiotecnico@awex.eu

Sistemi Central Battery AC/DC 230Vdc disponibili su richiesta

Sistemi Central Battery mod.LPS

AC/DC 230Vdc disponibili su richiesta



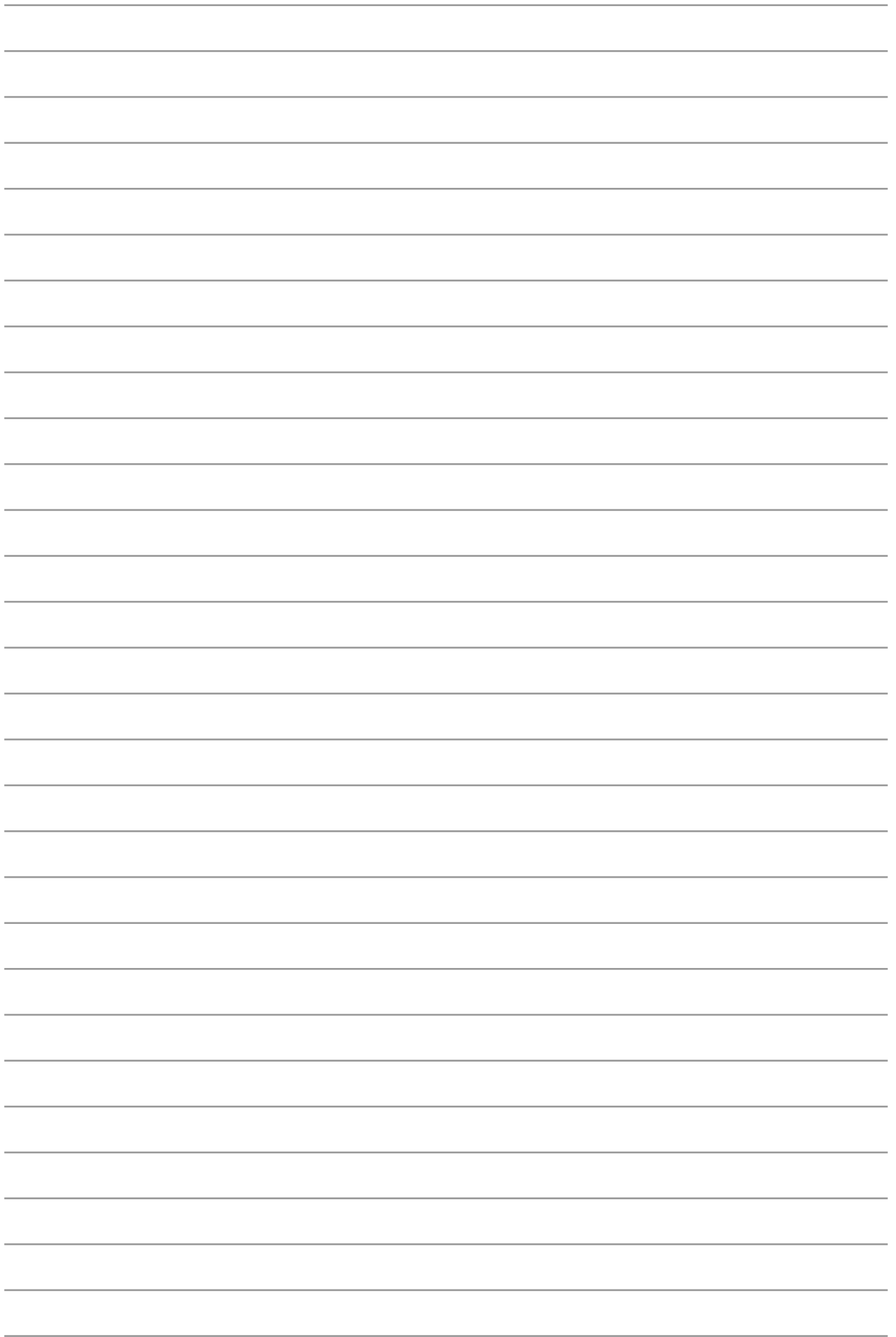

awex[®]

www.awex.eu/el/it

AWEX ITALIA SRL
VIA DE GASPERI 253
63078 MONTEPRANDONE (AP)

e-mail: infoawexitalia@awex.eu
e-mail: ufficiotecnico@awex.eu